



CD/USB RECEIVER WITH ADVANCED BLUETOOTH
CDE-175BT/CDE-172BT

CD/USB RECEIVER
CDE-170

USB RECEIVER WITH ADVANCED BLUETOOTH
UTE-73BT

- OWNER'S MANUAL
Please read before using this equipment.
- MODE D'EMPLOI
Veuillez lire avant d'utiliser cet appareil.
- MANUAL DE OPERACIÓN
Léalo antes de utilizar este equipo.

Thank you for purchasing this Alpine product. Please take a moment to protect your purchase by registering your product now at the following address: www.alpine-usa.com/registration. You will be informed of product and software updates (if applicable), special promotions, news about Alpine, and entered for a chance to win prizes.

Merci d'avoir acheté ce produit Alpine. Nous vous invitons à consacrer un moment à la protection de votre achat en enregistrant votre produit dès maintenant à l'adresse suivante : www.alpine-usa.com/registration.

Vous serez tenu informé des mises à jour des produits et des logiciels (le cas échéant), des promotions spéciales, de l'actualité d'Alpine, et vous aurez une chance de remporter des prix.

Gracias por adquirir este producto Alpine. Con solo unos pocos pasos podrá proteger su producto, registrándolo a través de la siguiente dirección: www.alpine-usa.com/registration.

Recibirá información sobre nuevos productos y software, promociones especiales, novedades sobre Alpine y participará en el sorteo de premios.

Printed in Thailand
68-40368Z01-E (Y-D)

ALPINE ELECTRONICS OF AMERICA, INC.
19145 Gramercy Place, Torrance,
California 90501, U.S.A.
Phone 1-800-ALPINE-1 (1-800-257-4631)



* 6 8 4 0 3 6 8 Z 0 1 E *

EN

FR

ES

For safety, be sure to install this unit in the dashboard of the car as the rear side of the unit becomes hot during use.
For details, see "Connection/Installation" (page 38).

The nameplate indicating operating voltage, etc., is located on the bottom of the chassis.

CAUTION

The use of optical instruments with this product will increase eye hazard.

Warning if your car's ignition has no ACC position

Be sure to set the AUTO OFF function (page 24). The unit will shut off completely and automatically in the set time after the unit is turned off, which prevents battery drain. If you do not set the AUTO OFF function, press and hold  (Power) until the display disappears each time you turn the ignition off.

Disclaimer regarding services offered by third parties

Services offered by third parties may be changed, suspended, or terminated without prior notice. Alpine does not bear any responsibility in these sorts of situations.

Important notice

Caution

IN NO EVENT SHALL ALPINE BE LIABLE FOR ANY INCIDENTAL, INDIRECT OR CONSEQUENTIAL DAMAGES OR OTHER DAMAGES INCLUDING, WITHOUT LIMITATION, LOSS OF PROFITS, LOSS OF REVENUE, LOSS OF DATA, LOSS OF USE OF THE PRODUCT OR ANY ASSOCIATED EQUIPMENT, DOWNTIME, AND PURCHASER'S TIME RELATED TO OR ARISING OUT OF THE USE OF THIS PRODUCT, ITS HARDWARE AND/OR ITS SOFTWARE.

Dear customer, this product includes a radio transmitter.

Please check your vehicle operation manual or contact the manufacturer of your vehicle or your vehicle dealer, before you install this product into your vehicle.

Emergency calls

This BLUETOOTH car handsfree and the electronic device connected to the handsfree operate using radio signals, cellular, and landline networks as well as user-programmed function, which cannot guarantee connection under all conditions.

Therefore do not rely solely upon any electronic device for essential communications (such as medical emergencies).

On BLUETOOTH communication

- Microwaves emitting from a BLUETOOTH device may affect the operation of electronic medical devices. Turn off this unit and other BLUETOOTH devices in the following locations, as it may cause an accident.
 - where inflammable gas is present, in a hospital, train, airplane, or petrol station
 - near automatic doors or a fire alarm
- This unit supports security capabilities that comply with the BLUETOOTH standard to provide a secure connection when the BLUETOOTH wireless technology is used, but security may not be enough depending on the setting. Be careful when communicating using BLUETOOTH wireless technology.

- We do not take any responsibility for the leakage of information during BLUETOOTH communication.

If you have any questions or problems concerning your unit that are not covered in this manual, consult your nearest Alpine dealer.

WARNING



WARNING

This symbol means important instructions. Failure to heed them can result in serious injury or death.

DO NOT OPERATE ANY FUNCTION THAT TAKES YOUR ATTENTION AWAY FROM SAFELY DRIVING YOUR VEHICLE.

Any function that requires your prolonged attention should only be performed after coming to a complete stop. Always stop the vehicle in a safe location before performing these functions. Failure to do so may result in an accident.

KEEP THE VOLUME AT A LEVEL WHERE YOU CAN STILL HEAR OUTSIDE NOISES WHILE DRIVING.

Excessive volume levels that obscure sounds such as emergency vehicle sirens or road warning signals (train crossings, etc.) can be dangerous and may result in an accident. LISTENING AT LOUD VOLUME LEVELS IN A CAR MAY ALSO CAUSE HEARING DAMAGE.

DO NOT DISASSEMBLE OR ALTER.

Doing so may result in an accident, fire or electric shock.

USE ONLY IN CARS WITH A 12 VOLT NEGATIVE GROUND.

(Check with your dealer if you are not sure.) Failure to do so may result in fire, etc.

KEEP SMALL OBJECTS SUCH AS BATTERIES OUT OF THE REACH OF CHILDREN.

Swallowing them may result in serious injury. If swallowed, consult a physician immediately.

USE THE CORRECT AMPERE RATING WHEN REPLACING FUSES.

Failure to do so may result in fire or electric shock.

DO NOT BLOCK VENTS OR RADIATOR PANELS.

Doing so may cause heat to build up inside and may result in fire.

USE THIS PRODUCT FOR MOBILE 12V APPLICATIONS.

Use for other than its designed application may result in fire, electric shock or other injury.

DO NOT PLACE HANDS, FINGERS OR FOREIGN OBJECTS IN INSERTION SLOTS OR GAPS.

Doing so may result in personal injury or damage to the product.

MAKE THE CORRECT CONNECTIONS.

Failure to make the proper connections may result in fire or product damage.

BEFORE WIRING, DISCONNECT THE CABLE FROM THE NEGATIVE BATTERY TERMINAL.

Failure to do so may result in electric shock or injury due to electrical shorts.

DO NOT SPLICE INTO ELECTRICAL CABLES.

Never cut away cable insulation to supply power to other equipment. Doing so will exceed the current carrying capacity of the wire and result in fire or electric shock.

DO NOT DAMAGE PIPE OR WIRING WHEN DRILLING HOLES.

When drilling holes in the chassis for installation, take precautions so as not to contact, damage or obstruct pipes, fuel lines, tanks or electrical wiring. Failure to take such precautions may result in fire.

DO NOT USE BOLTS OR NUTS IN THE BRAKE OR STEERING SYSTEMS TO MAKE GROUND CONNECTIONS.

Bolts or nuts used for the brake or steering systems (or any other safety-related system), or tanks should NEVER be used for installations or ground connections. Using such parts could disable control of the vehicle and cause fire etc.

DO NOT INSTALL IN LOCATIONS WHICH MIGHT HINDER VEHICLE OPERATION, SUCH AS THE STEERING WHEEL OR GEARSHIFT.

Doing so may obstruct forward vision or hamper movement etc. and results in serious accident.

DO NOT INSTALL IN LOCATIONS WITH HIGH MOISTURE OR DUST.

Avoid installing the unit in locations with high incidence of moisture or dust. Moisture or dust that penetrates into this unit may result in product failure.



This symbol means important instructions. Failure to heed them can result in injury or material property damage.

HALT USE IMMEDIATELY IF A PROBLEM APPEARS.

Failure to do so may cause personal injury or damage to the product. Return it to your authorized Alpine dealer or the nearest Alpine Service Center for repairing.

HAVE THE WIRING AND INSTALLATION DONE BY EXPERTS.

The wiring and installation of this unit requires special technical skill and experience. To ensure safety, always contact the dealer where you purchased this product to have the work done.

USE SPECIFIED ACCESSORY PARTS AND INSTALL THEM SECURELY.

Be sure to use only the specified accessory parts. Use of other than designated parts may damage this unit internally or may not securely install the unit in place. This may cause parts to become loose resulting in hazards or product failure.

ARRANGE THE WIRING SO IT IS NOT CRIMPED OR PINCHED BY A SHARP METAL EDGE.

Route the cables and wiring away from moving parts (like the seat rails) or sharp or pointed edges. This will prevent crimping and damage to the wiring. If wiring passes through a hole in metal, use a rubber grommet to prevent the wire's insulation from being cut by the metal edge of the hole.

Table of Contents

WARNING	4
Guide to Parts and Controls	7

Getting Started

Detaching the Front Panel	10
Resetting the Unit	10
Setting the Clock	10
Preparing a BLUETOOTH Device (CDE-175BT/ CDE-172BT/ UTE-73BT only)	11
Connecting a USB Device	13
Connecting Other Portable Audio Device	13

Listening to the Radio

Listening to the Radio	14
Using Radio Data System (RDS)	14
Listening to the SiriusXM Radio (CDE-175BT/ CDE-172BT only)	15

Playback

Playing a Disc (CDE-175BT/ CDE-172BT/ CDE-170 only)	16
Playing a USB Device	16
Playing a BLUETOOTH Device (CDE-175BT/ CDE-172BT/ UTE-73BT only)	17
Searching and Playing Tracks	18

Listening to Pandora® (CDE-175BT/ CDE-172BT/ UTE-73BT only)

Setting up Pandora®	19
Streaming Pandora®	19
Available Operations in Pandora®	19

Handsfree Calling (via BLUETOOTH only) (CDE-175BT/ CDE-172BT/ UTE-73BT only)

Receiving a Call	20
Making a Call	20
Available Operations during Call	21

Useful Functions

Adjusting Bass Level/ Mid Level/ Treble Level/ Subwoofer Level/ Balance (Between Left and Right)/ Fader (Between Front and Rear)	22
Setting the BASS ENGINE SQ	22
Using Siri Eyes Free (CDE-175BT/ CDE-172BT/ UTE-73BT only)	22

Settings

Canceling the DEMO Mode	24
Basic Setting Operation	24
General Setup (GENERAL)	24
Audio Setup (AUDIO)	25
Display Setup (DISPLAY)	25
BLUETOOTH Setup (BLUETOOTH) (CDE-175BT/ CDE-172BT/ UTE-73BT only)	26

Additional Information

Updating the Firmware	27
Precautions	27
Maintenance	28
Specifications	29
Troubleshooting	31
Messages	35

Connection/Installation

Cautions	38
Parts List for Installation	38
Connection	39
Installation	43

Guide to Parts and Controls

Main unit

■ CDE-175BT/CDE-172BT / UTE-73BT

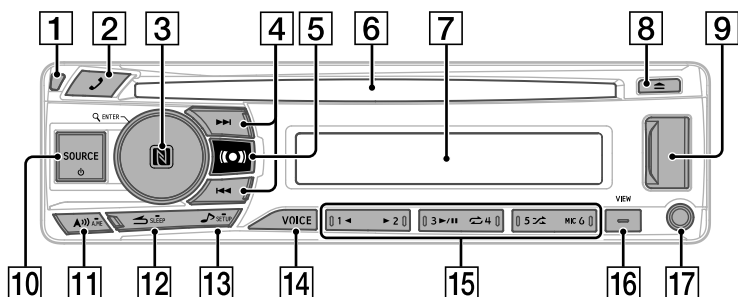

■ CDE-170

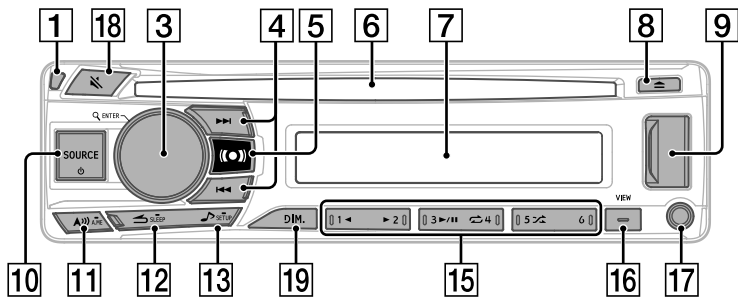

1 Front panel release button



Enter the call menu. Receive/end a call.
Press and hold for more than 2 seconds to switch the BLUETOOTH signal.

3 Control dial

Rotate to adjust the volume.

ENTER

Enter the selected item.

Q (browse) (pages 14, 15, 18, 19)

Enter the browse mode during playback.
(Not available when a USB device in Android mode or iPod is connected.)
Select PTY in RDS.

N-Mark (CDE-175BT only)

Touch the control dial with ANDROID smartphone to make BLUETOOTH connection.



Radio mode:

Tune in radio stations automatically. Press and hold to tune manually.

Disc/USB Device mode:

Switch between previous/next song.
Press and hold for 2 seconds to fast-reverse/
fast-forward.

SiriusXM mode (CDE-175BT/ CDE-172BT only):

Press to ascend or descend through Channel numbers.

Pandora® mode (CDE-175BT/ CDE-172BT/ UTE-73BT only):

Press  to skip to next song.

5 (pages 22)

6 (CDE-175BT/ CDE-172BT/ CDE-170 only)

7 Display window

8 (disc eject) (CDE-175BT/ CDE-172BT/ CDE-170 only)

9 USB port

10 SOURCE

Change the source.

(Power)

Turn on the power.

Press and hold for more than 2 seconds to turn off the power and the display.

11 (A))

Press in the Radio mode to change the radio band.

Press in SiriusXM mode to switch bands.

Press in Pandora mode to bookmark.

A.M.E

Press and hold for more than 2 seconds in the Radio mode to store stations automatically.

12 (back)

Return to the previous display.

SLEEP

Press and hold for 2 seconds to turn the source off and display the clock.

13 (page 22)

Open audio setup mode directly.

SETUP

Press and hold to open the setup menu.

14 VOICE (pages 21, 22)

Press to activate voice dial, voice recognition (Android™ smartphone only), or the Siri function (iPhone only).



15 Number buttons (1 to 6)

Receive stored radio stations. Press and hold to store stations.



Skip an album for audio device. Press and hold to skip albums continuously.

(Not available when a USB device in Android mode or iPod is connected.)

Press  to thumbs up, or  to thumbs down in Pandora® (page 19).

/ (play/pause)

(repeat)

(Not available when a USB device in Android mode is connected.)

(shuffle)

(Not available when a USB device in Android mode is connected.)

MIC (CDE-175BT/ CDE-172BT/ UTE-73BT only) (page 21)

16 VIEW

Change display items.

(scroll)

Press and hold to scroll a display item.

17 AUX input jack

18 (MUTE)

Set the mute mode to on/off.

19 DIM.

Press to change the Dimmer function.

Controllable with Remote Control

This unit can be controlled with an optional Alpine remote control. For details, consult your Alpine dealer.

Point the optional remote control transmitter at the remote-control sensor.

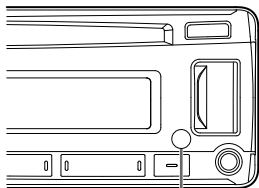

Remote control sensor

Connectable to Remote Control Interface Box

With an optional Alpine Steering Wheel Remote Control Interface Box, this unit is controllable from the vehicles steering wheel controls. For details, contact your Alpine dealer.

Getting Started

To cancel the demonstration (DEMO) display, see page 24.

For the connection/installation, see page 38.

Detaching the Front Panel

You can detach the front panel of this unit to prevent theft.

- 1 Press and hold  (Power) ① until the unit turns off, press the front panel release button ②, then pull the panel towards you to remove.

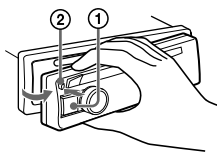

Caution alarm

If you turn the ignition switch to the OFF position without detaching the front panel, the caution alarm will sound for a few seconds. The alarm will only sound if the built-in amplifier is used.

Serial numbers (CDE-175BT only)

Make sure the serial numbers on the bottom of the unit and the back of the front panel are matched correctly. Otherwise you cannot make BLUETOOTH pairing, connection and disconnection by NFC.

Attaching the front panel

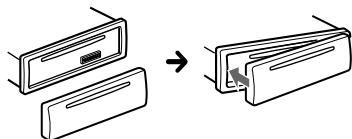

Resetting the Unit





Before operating the unit for the first time, or after replacing the car battery or changing connections, you must reset the unit.

- 1 Press  and Number button 6 for more than 2 seconds.

Note

Resetting the unit will erase the clock setting and some stored contents.

Setting the Clock

- 1 Press and hold  /SETUP for at least 2 seconds, rotate the control dial to select [GENERAL], then press it.
- 2 Rotate the control dial to select [CLOCK ADJ], then press it.
The hour indication flashes.
- 3 Rotate the control dial to adjust the hour and minute.
To move the digital indication, press  / .
- 4 Press ENTER to set the hour and minute.
- 5 Press  (back) twice.
The setup is complete.

To display the clock

Press VIEW.

Preparing a BLUETOOTH Device (CDE-175BT/ CDE-172BT/ UTE-73BT only)

You can enjoy music, or perform handsfree calling depending on the BLUETOOTH compatible device such as a smartphone, cellular phone and audio device (hereafter "BLUETOOTH device" if not otherwise specified). For details on connecting, refer to the operating instructions supplied with the device.

Before connecting the device, turn down the volume of this unit; otherwise, loud sound may result.

Connecting with a Smartphone by One touch (NFC) (CDE-175BT only)

By touching the control dial on the unit with an NFC* compatible smartphone, the unit is paired and connected with the smartphone automatically.

* NFC (Near Field Communication) is a technology enabling short-range wireless communication between various devices, such as mobile phones and IC tags.

Thanks to the NFC function, data communication can be achieved easily just by touching the relevant symbol or designated location on NFC compatible devices.

For a smartphone with Android OS 4.0 or lower installed, downloading the app "NFC Easy Connect" available at Google Play™ is required. The app may not be downloadable in some countries/regions.

1 Activate the NFC function on the smartphone.

For details, refer to the operating instructions supplied with the smartphone.

2 Touch the N-Mark part of the unit with the N-Mark part of the smartphone.

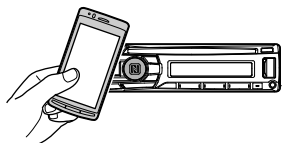

Make sure that  lights up on the display of the unit.

To disconnect by One touch

Touch the N-Mark part of the unit with the N-Mark part of the smartphone again.



Notes

- When making the connection, handle the smartphone carefully to prevent scratches.
- One touch connection is not possible when the unit is already connected to two NFC compatible devices. In this case, disconnect either device, and make connection with the smartphone again.

Pairing and connecting with a BLUETOOTH device

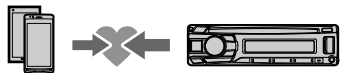
When connecting a BLUETOOTH device for the first time, mutual registration (called "pairing") is required. Pairing enables this unit and other devices to recognize each other. This unit can connect two BLUETOOTH devices (two cellular phones, or a cellular phone and an audio device).



- 1 Place the BLUETOOTH device within 1 m (3 ft) of this unit.
 - 2 Press and hold /SETUP for at least 2 seconds, rotate the control dial to select [BLUETOOTH], then press it.
 - 3 Rotate the control dial to select [PAIRING], then press it.
 - 4 Rotate the control dial to select [SET DEVICE 1]* or [SET DEVICE 2]*, then press it.
 flashes while the unit is in pairing standby mode.
- * [SET DEVICE 1] or [SET DEVICE 2] will be changed to the paired device name after pairing is complete.
- 5 Perform pairing on the BLUETOOTH device so it detects this unit.

- 6** Select [CDE-175BT] [CDE-172BT] [UTE-73BT] (your model name) shown in the display of the BLUETOOTH device.

If your model name does not appear, repeat from step 2.

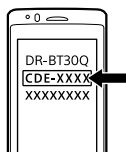

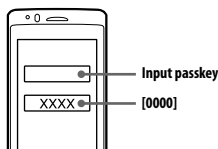

- 7** If passkey* input is required on the BLUETOOTH device, input [0000].

* Passkey may be called "Passcode," "PIN code," "PIN number" or "Password," etc., depending on the device.



When pairing is made,  stays lit.

- 8** Select this unit on the BLUETOOTH device to establish the BLUETOOTH connection.

 or  lights up when the connection is made.

Note

While connecting to a BLUETOOTH device, this unit cannot be detected from another device. To enable detection, enter the pairing mode and search for this unit from another device.

To start playback

For details, see "Playing a BLUETOOTH Device (CDE-175BT/ CDE-172BT/ UTE-73BT only)" (page 17).





To disconnect the paired device

Perform steps 2 to 4 to disconnect after this unit and the BLUETOOTH device are paired.



Connecting with a paired BLUETOOTH device

To use a paired device, connection with this unit is required. Some paired devices will connect automatically.



- 1** Press and hold /SETUP for at least 2 seconds, rotate the control dial to select [BLUETOOTH], then press it.
- 2** Rotate the control dial to select [BT IN], then press it.
Make sure that  lights up.
- 3** Activate the BLUETOOTH function on the BLUETOOTH device.
- 4** Operate the BLUETOOTH device to connect to this unit.
 or  lights up.

Icons in the display:

	Lights up when handsfree calling is available by enabling the HFP (Handsfree Profile).
	Lights up when the audio device is playable by enabling the A2DP (Advanced Audio Distribution Profile).

To connect the last-connected device from this unit

Activate the BLUETOOTH function on the BLUETOOTH device.

To connect with the audio device, press SOURCE  to select [BT AUDIO].

To connect with the cellular phone, press .

Note

While streaming BLUETOOTH audio, you cannot connect from this unit to the cellular phone. Connect from the cellular phone to this unit instead.

Tip

With BLUETOOTH signal on: when the ignition is turned to on, this unit reconnects automatically to the last-connected cellular phone.

To install the microphone

For details, see "Installing the microphone (CDE-175BT/ CDE-172BT/ UTE-73BT only)" (page 42).

Connecting with an iPhone/iPod (BLUETOOTH Auto Pairing)

When an iPhone/iPod with iOS5 or later installed is connected to the USB port, the unit is paired and connected with the iPhone/iPod automatically.

To enable BLUETOOTH Auto Pairing, make sure [AUTO PAIR] in [BLUETOOTH] is set to [ON] (page 26).

- 1 Activate the BLUETOOTH function on the iPhone/iPod.
- 2 Connect an iPhone/iPod to the USB port.

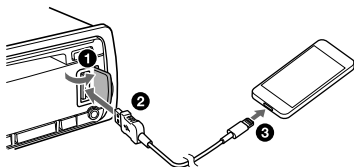

Make sure that ③ lights up on the display of the unit.

Notes

- BLUETOOTH Auto Pairing is not possible if the unit is already connected to two BLUETOOTH devices. In this case, disconnect either device, then connect the iPhone/iPod again.
- If BLUETOOTH Auto Pairing is not established, see "Preparing a BLUETOOTH Device (CDE-175BT/ CDE-172BT/ UTE-73BT only)" (page 11).

Connecting a USB Device

- 1 Turn down the volume on the unit.
- 2 Connect the USB device to the unit.
To connect an iPod/iPhone, use the USB connection cable for iPod (not supplied) (CDE-175BT/ CDE-172BT/ UTE-73BT only).

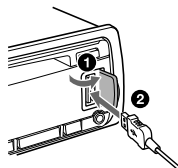

Connecting Other Portable Audio Device

- 1 Turn off the portable audio device.
- 2 Turn down the volume on the unit.
- 3 Connect the portable audio device to the AUX input jack (stereo mini jack) on the unit with a connecting cord (not supplied)*.

* Be sure to use a straight type plug.

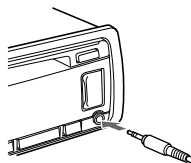

- 4 Press SOURCE ϕ to select [AUX].

To match the volume level of the connected device to other sources

Start playback of the portable audio device at a moderate volume, and set your usual listening volume on the unit.

Press and hold \mathbb{A} /SETUP for at least 2 seconds, then select [AUDIO] \rightarrow [AUX VOL] (page 25).

Listening to the Radio

Listening to the Radio

To listen to the radio, press SOURCE  to select [TUNER].

Storing automatically

- 1 Press **A** (or **A.ME**) to change the band (FM1, FM2, FM3, AM1 or AM2).
- 2 Press and hold **A** (or **A.ME**) for at least 2 seconds.
The unit stores stations in order of frequency on the number buttons.

Tuning

- 1 Press **A** (or **A.ME**) to change the band (FM1, FM2, FM3, AM1 or AM2).
- 2 Perform tuning.
To tune manually
Press and hold **◀▶** to locate the approximate frequency, then press **◀▶** repeatedly to finely adjust to the desired frequency.
To tune automatically
Press **◀▶**.
Scanning stops when the unit receives a station.

Storing manually

- 1 While receiving the station that you want to store, press and hold a number button (1 to 6) until [MEM] appears.

Receiving the stored stations

- 1 Select the band, then press a number button (1 to 6).

Using Radio Data System (RDS)

Selecting program types (PTY)

- 1 Press **Q** (browse) during FM reception.
- 2 Rotate the control dial until the desired program type appears, then press it.
The unit starts to search for a station broadcasting the selected program type.

Type of programs

NEWS (News), **INFORM** (Information), **SPORTS** (Sports), **TALK** (Talk), **ROCK** (Rock), **CLS ROCK** (Classic Rock), **ADLT HIT** (Adult Hits), **SOFT RCK** (Soft Rock), **TOP 40** (Top 40), **COUNTRY** (Country), **OLDIES** (Oldies), **SOFT** (Soft), **NOSTALGA** (Nostalgia), **JAZZ** (Jazz), **CLASSICL** (Classical), **R & B** (Rhythm and Blues), **SOFT R&B** (Soft Rhythm and Blues), **LANGUAGE** (Foreign Language), **REL MUSC** (Religious Music), **REL TALK** (Religious Talk), **PERSONLTY** (Personality), **PUBLIC** (Public), **COLLEGE** (College), **HABL ESP** (Spanish Talk), **MUSC ESP** (Spanish Music), **HIP HOP** (Hip-Hop), **WEATHER** (Weather)

Setting clock time (RDS CT)

The CT data from the RDS transmission sets the clock.

- 1 Set [RDS CT ON] in [GENERAL] (page 24).

Listening to the SiriusXM Radio (CDE-175BT/ CDE-172BT only)

Activating your SiriusXM Subscription

Only SiriusXM® brings you more of what you love to listen to, all in one place. Get over 140 channels, including commercial-free music plus the best sports, news, talk, comedy and entertainment. Welcome to the world of satellite radio. A SiriusXM Connect Vehicle Tuner and Subscription are required. For more information, visit www.siriusxm.com

After installing your SiriusXM Connect Vehicle Tuner and antenna, press SOURCE  to select [SIRIUS XM]. You should be able to hear the SiriusXM preview channel on Channel 1. After verifying that you can hear the preview channel, select Channel 0 to find the Radio ID of your tuner. In addition, the Radio ID is located on the bottom of the SiriusXM Connect Vehicle Tuner and its packaging. You will need this number to activate your subscription. Write the number down for reference.

Note

The SiriusXM Radio ID does not include the letters I, O, S or F.

In the USA, you can activate online or by calling SiriusXM Listener Care:

- Online: Visit www.siriusxm.com/activatenow
- Phone: Call 1-866-635-2349

In Canada, you can activate online or by calling SiriusXM Listener Care:

- Online: Visit www.siriusxm.ca/activatexm
- Phone: Call 1-877-438-9677

As part of the activation process, the SiriusXM satellites will send an activation message to your tuner. When your radio detects that the tuner has received the activation message, your radio will display: [SUBSCRIPTION UPDATED - PRESS ENT TO CONTINUE]. Once subscribed, you can tune to channels in your subscription plan.

Notes

- The activation process usually takes 10 to 15 minutes, but may take up to an hour.
- Your radio will need to be turned on and receiving the SiriusXM signal to receive the activation message.

Selecting channels for SiriusXM

- 1 Press  (browse).
- 2 Rotate the control dial to select [CHANNEL], then press it.
- 3 Rotate the control dial to select the desired channel, then press it.

To select channels from categories

- 1 Press  (browse).
- 2 Rotate the control dial to select [CATEGORY], then press it.
- 3 Rotate the control dial to select the desired category, then press it. The channel list appears.
- 4 Rotate the control dial to select the desired channel, then press it.



To store channels

- 1 While receiving the channel that you want to store, press and hold a number button (1 to 6) until [MEM] appears.

To receive the stored channel, press /A.ME to select [SX1], [SX2] or [SX3], then press a number button (1 to 6).

To set a parental control

The parental control feature allows you to limit access to SiriusXM channels with mature content. When enabled, the parental control feature requires you to enter a passcode to tune to the locked channels. Information on setting up the passcode and locking channels can be found below.

- 1 Press and hold /SETUP for at least 2 seconds and rotate the control dial.
- 2 Select [GENERAL] → [SXM PARENTAL] → [LOCK SELECT] → [LOCK ON].
- 3 Enter the passcode by rotating the control dial on the unit.
To move the entry position, press /  on the unit.
The initial passcode is [0000].
- 4 After entering the passcode, press ENTER.

To unlock the channels, select [LOCK OFF].

To change the passcode

- 1 Press and hold /SETUP for at least 2 seconds and rotate the control dial.
- 2 Select [GENERAL] → [SXM PARENTAL] → [CODE EDIT].
- 3 Enter the current passcode on the current passcode input display, then press ENTER.
The initial passcode is [0000].
- 4 Enter your new 4-digit passcode on the new passcode input display, then press ENTER.

To change display items

Press VIEW to change as follows:

Channel Number (Default) → Channel Name →
Artist Name → Song Title → Content Info →
Channel Name → Clock

Playback

Playing a Disc (CDE-175BT/ CDE-172BT/ CDE-170 only)

- 1 Insert the disc (label side up).

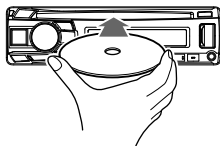

Playback starts automatically.

Playing a USB Device

In these Operating Instructions, “iPod” is used as a general reference for the iPod functions on an iPod and iPhone, unless otherwise specified by the text or illustrations. (iPod/iPhone operation is available on CDE-175BT/ CDE-172BT/ UTE-73BT only.)

For details on the compatibility of your iPod, see “About iPod (CDE-175BT/ CDE-172BT/ UTE-73BT only)” (page 28).

AOA (Android Open Accessory) 2.0, MSC (Mass Storage Class) and MTP (Media Transfer Protocol) type USB devices* compliant with the USB standard can be used. Depending on the USB device, the Android mode or MSC/MTP mode can be selected on the unit.

Some digital media players or Android smartphones may require setting to MTP mode.

* e.g., a USB flash drive, digital media player, Android smartphone

Notes

- For details on the compatibility of your USB device, consult your nearest Alpine dealer.
- Smartphones with Android OS 4.1 or higher installed support Android Open Accessory 2.0 (AOA 2.0). However, some smartphones may not fully support AOA 2.0 even if Android OS 4.1 or higher is installed. For details on the compatibility of your Android smartphone, consult your nearest Alpine dealer.

- Playback of the following files is not supported.

MP3/WMA/FLAC/AAC*:

- copyright-protected files
 - DRM (Digital Rights Management) files
 - Multi-channel audio files
- MP3/WMA/AAC*:
- lossless compression files

* CDE-175BT/ CDE-172BT/ UTE-73BT only

Before making a connection, select the USB mode (Android mode or MSC/MTP mode) depending on the USB device (page 24).

1 Connect a USB device to the USB port (page 13).

Playback starts.

If a device is already connected, to start playback, press SOURCE  to select [USB] ([IPD] appears in the display when the iPod is recognized) (CDE-175BT/ CDE-172BT/ UTE-73BT only).

2 Adjust the volume on this unit.

To stop playback

Press and hold SLEEP for 2 seconds.

To remove the device

Stop playback, then remove the device.

Caution for iPhone

When you connect an iPhone via USB, phone call volume is controlled by the iPhone, not the unit. Do not inadvertently increase the volume on the unit during a call, as a sudden loud sound may result when the call ends.

Playing a BLUETOOTH Device (CDE-175BT/ CDE-172BT/ UTE-73BT only)

You can play contents on a connected device that supports BLUETOOTH A2DP (Advanced Audio Distribution Profile).



1 Make BLUETOOTH connection with the audio device (page 11).

To select the audio device, press and hold /SETUP for at least 2 seconds, then select [BLUETOOTH] → [AUDIO DEVICE] (page 26).

2 Press SOURCE to select [BT AUDIO].

3 Operate the audio device to start playback.

4 Adjust the volume on this unit.

Notes

- Depending on the audio device, information such as title, track number/time and playback status may not be displayed on this unit.
- Even if the source is changed on this unit, playback of the audio device does not stop.

To match the volume level of the BLUETOOTH device to other sources



Start playback of the BLUETOOTH audio device at a moderate volume, and set your usual listening volume on the unit.

Press and hold /SETUP for at least 2 seconds, then select [AUDIO] → [BTA VOL.] (page 25).

Searching and Playing Tracks

Repeat play and shuffle play



Not available when a USB device in Android mode is connected.

- 1 During playback, press  (repeat) or  (shuffle) repeatedly to select the desired play mode.
Playback in the selected play mode may take time to start.

Available play modes differ depending on the selected sound source.



Searching a track by name

Not available when a USB device in Android mode or iPod is connected.

- 1 During CD or USB playback, press  (browse) to display the list of search categories.
When the track list appears, press  (back) repeatedly to display the desired search category.
- 2 Rotate the control dial to select the desired search category, then press it to confirm.
- 3 Repeat step 2 to search the desired track.
Playback starts.

Searching by skipping items (Jump mode)

Not available when a USB device in Android mode or iPod is connected.

- 1 Press  (browse).
- 2 Press .
- 3 Rotate the control dial to select the item.
The list is jumped in steps of 10% of the total number of items.

- 4 Press ENTER to return to the browse mode.
The selected item appears.
- 5 Rotate the control dial to select the desired item, then press it.
Playback starts.



Listening to Pandora® (CDE-175BT/ CDE-172BT/ UTE-73BT only)

Pandora® is available to stream music through your iPhone and Android smartphone. You can control Pandora® on a BLUETOOTH connected iPhone/Android smartphone from this unit. Pandora® is only available in certain countries. Please visit <http://www.pandora.com/legal> for more information.

Setting up Pandora®

- 1 Download the latest version of the Pandora® application from your smartphone's app store. A list of compatible devices can be found at www.pandora.com/everywhere/mobile

Streaming Pandora®

- 1 Make BLUETOOTH connection with the audio device (page 11).
To select the audio device, press and hold  SETUP for at least 2 seconds, then select [BLUETOOTH] → [AUDIO DEVICE] (page 26).
- 2 Press SOURCE  to select [PANDORA].
- 3 Launch Pandora® application on your mobile device.
- 4 Press  (play/pause) to start playback.

If the device number appears

Make sure that the same numbers are displayed (e.g., 123456) in this unit and the mobile device, then press ENTER on this unit and select [Yes] on the mobile device.

When activating the BLUETOOTH function

You can adjust the volume level.
Press and hold  / SETUP for at least 2 seconds, then select [AUDIO] → [BTA VOL] (page 25).

Available Operations in Pandora®



"Thumbs" feedback

"Thumbs Up" or "Thumbs Down" feedback allows you to personalize stations.

- 1 During playback, press  (Thumbs Up) or  (Thumbs Down).

Using the station list

The station list allows you to easily select a desired station.

- 1 During playback, press  (browse).
- 2 Press  to select the sorting order [BY DATE] or [A TO Z].
- 3 Rotate the control dial to select the desired station, then press it.
Playback starts.

Bookmarking

The track currently being played can be bookmarked and stored in your Pandora® account.

- 1 During playback, press .

Handsfree Calling (via BLUETOOTH only) (CDE-175BT/ CDE-172BT/ UTE-73BT only)

To use a cellular phone, connect it with this unit. You can connect two cellular phones to the unit. For details, see "Preparing a BLUETOOTH Device (CDE-175BT/ CDE-172BT/ UTE-73BT only)" (page 11).



Receiving a Call

- 1 Press when a call is received with a ringtone.

The phone call starts.

Note

The ringtone and talker's voice are output only from the front speakers.

To reject the call

Press and hold SLEEP for 2 seconds.

To end the call

Press again.

Making a Call

You can make a call from the phonebook or call history when a cellular phone supporting PBAP (Phone Book Access Profile) is connected.

When two cellular phones are connected to the unit, select either phone.

From the phonebook

- 1 Press .

When two cellular phones are connected to the unit, rotate the control dial to select either phone, then press it.

- 2 Rotate the control dial to select [PHONE BOOK], then press it.
- 3 Rotate the control dial to select an initial from the initial list, then press it.
- 4 Rotate the control dial to select a name from the name list, then press it.
- 5 Rotate the control dial to select a number from the number list, then press it.
The phone call starts.

From the call history

- 1 Press .

When two cellular phones are connected to the unit, rotate the control dial to select either phone, then press it.

- 2 Rotate the control dial to select [HISTORY], then press it.
A list of the call history appears.
- 3 Rotate the control dial to select a name or phone number from the call history, then press it.
The phone call starts.

By phone number input

- 1 Press .

When two cellular phones are connected to the unit, rotate the control dial to select either phone, then press it.

- 2 Rotate the control dial to select [DIAL NUMBER], then press it.
- 3 Rotate the control dial to enter the phone number, and lastly select [] (space), then press ENTER*.
The phone call starts.

* To move the digital indication, press / .

Note

[_] appears instead of [#] on the display.

By redial

- 1 Press .**
When two cellular phones are connected to the unit, rotate the control dial to select either phone, then press it.
- 2 Rotate the control dial to select [REDIAL], then press it.**
The phone call starts.

By voice tags

You can make a call by saying the voice tag stored in a connected cellular phone that has a voice dialing function.

- 1 Press .**
When two cellular phones are connected to the unit, rotate the control dial to select either phone, then press it.
- 2 Rotate the control dial to select [VOICE DIAL], then press it.**
Alternatively, press VOICE.
- 3 Say the voice tag stored on the cellular phone.**
Your voice is recognized, and the call is made.

To cancel voice dialing

Press VOICE.

Available Operations during Call

To adjust the ringtone volume

Rotate the control dial while receiving a call.

To adjust the talker's voice volume

Rotate the control dial during a call.

To adjust the volume for the other party (Mic gain adjustment)

Press MIC.

Adjustable volume levels: [MIC GAIN LOW], [MIC GAIN MID], [MIC GAIN HI].

To reduce echo and noise (Echo Canceler/ Noise Canceler Mode)

Press and hold MIC.

Settable mode: [BTP EC/NC 1], [BTP EC/NC 2].

To switch between handsfree mode and handheld mode

During a call, press /A.ME to switch the phone call audio between the unit and cellular phone.

Note

Depending on the cellular phone, this operation may not be available.

Useful Functions

Adjusting Bass Level/ Mid Level/ Treble Level/ Subwoofer Level/ Balance (Between Left and Right)/ Fader (Between Front and Rear)

- 1 Press /SETUP.
- 2 Rotate the control dial to adjust the each mode, then press it.

Each press changes the mode as follows:
BASS → MID → TREBLE → SUBW → BALANCE → FADER

Bass Level	-7 to +7
Mid Level	-7 to +7
Treble Level	-7 to +7
Subwoofer Level	OFF to 0 to +15
Balance	L15 to R15
Fader	R15 to F15

- 3 Press /SETUP to return the normal mode.

Notes

- If no operation is performed for 5 seconds, the unit automatically returns to normal mode.
- When Bass/Mid/Treble/Subwoofer Level is adjusted, BASS ENGINE SQ is set to [OFF] (page 22).

Setting the BASS ENGINE SQ

Creating the ideal Bass impact for your musical taste using BASS ENGINE SQ.

- 1 Press .
- 2 Rotate the control dial to adjust [BASS ENGINE], then press it.

Setting contents: [OFF], [1]-[6]

Note

When Bass/Mid/Treble/Subwoofer Level is adjusted, BASS ENGINE SQ is set to [OFF] (page 22).

Using Siri Eyes Free (CDE-175BT/ CDE-172BT/ UTE-73BT only)

Siri Eyes Free allows you to use an iPhone handsfree by simply speaking into the microphone. This function requires you to connect an iPhone to the unit via BLUETOOTH. Availability is limited to iPhone 4s or later. Make sure that your iPhone is running the latest iOS version.

You must complete BLUETOOTH registration and connection configurations for the iPhone with the unit in advance. For details, see "Preparing a BLUETOOTH Device (CDE-175BT/ CDE-172BT/ UTE-73BT only)" (page 11). To select the iPhone, press and hold /SETUP for at least 2 seconds, then select [BLUETOOTH] → [AUDIO DEVICE] (page 26).

- 1 **Activate the Siri function on the iPhone.**
For details, refer to the operating instructions supplied with the iPhone.
- 2 **Press VOICE.**
The voice command display appears.
- 3 **After the iPhone beeps, speak into the microphone.**
The iPhone beeps again, then Siri starts responding.

To deactivate Siri Eyes Free

Press VOICE.

Notes

- The iPhone may not recognize your voice depending on usage conditions. (For example, if you are in a moving car.)
- Siri Eyes Free may not function properly, or the response time may lag in locations where iPhone signals are difficult to receive.
- Depending on the iPhone's operating condition, Siri Eyes Free may not function properly, or may quit.
- If you play a track with an iPhone using the BLUETOOTH audio connection, when the track starts playback via BLUETOOTH, Siri Eyes Free automatically quits and the unit switches to the BLUETOOTH audio source.
- When Siri Eyes Free is activated during audio playback, the unit may switch to the BLUETOOTH audio source even if you do not specify a track to play.
- When connecting the iPhone to the USB port, Siri Eyes Free may not function properly, or may quit.

- When connecting the iPhone to the unit via USB, do not activate Siri with the iPhone. Siri Eyes Free may not function properly, or may quit.
- There is no audio sound while Siri Eyes Free is activated.

Settings

Canceling the DEMO Mode

You can cancel the demonstration display which appears when the source is off and the clock is displayed.

- 1 Press and hold /SETUP for at least 2 second, rotate the control dial to select [GENERAL], then press it.
- 2 Rotate the control dial to select [DEMO MODE], then press it.
- 3 Rotate the control dial to select [DEMO OFF], then press it.
The setting is complete.
- 4 Press (back) twice.
The display returns to normal reception/play mode.

Basic Setting Operation

You can set items in the following setup categories:
General setup (GENERAL), Audio setup (AUDIO), Display setup (DISPLAY), BLUETOOTH setup (BLUETOOTH)

- 1 Press and hold /SETUP for at least 2 seconds.
- 2 Rotate the control dial to select the setup category, then press it.
The items that can be set differ depending on the source and settings.
- 3 Rotate the control dial to select the options, then press it.

To return to the previous display

Press (back).

General Setup (GENERAL)

DEMO MODE (demonstration)

Activates the demonstration: [ON], [OFF].

CLOCK ADJ (clock adjust) (page 10)

CAUTION ALM (caution alarm)

Activates the caution alarm: [ON], [OFF] (page 10).

(Available only while the source is off and the clock is displayed.)

BEEP

Activates the beep sound: [ON], [OFF].

AUTO OFF

Shuts off automatically after a desired time when the unit is turned off: [ON] (30 minutes), [OFF].

USB MODE

Changes the USB mode: [MSC/MTP], [ANDROID].

(Available only when the USB source is selected.)

RDS CT (clock time)

Activates the CT function: [ON], [OFF].

SXM PARENTAL (CDE-175BT/ CDE-172BT only)

Sets the parental lock to [ON], [OFF], and edits the passcode (page 16).

(Available only when SiriusXM is selected.)

SMX SIGNAL (CDE-175BT/ CDE-172BT only)

Displays the current status of the SiriusXM signal strength: [NO SIGNAL] (signal level 0), [WEAK] (signal level 1), [GOOD] (signal level 2), [EXCELLENT] (signal level 3).

(Available only when SiriusXM is selected.)

SXM RESET (CDE-175BT/ CDE-172BT only)

Initializes the SiriusXM Connect Vehicle Tuner settings (preset channels/parental lock): [YES], [NO].

(Available only when SiriusXM is selected.)

FIRMWARE

(Available only while the source is off and the clock is displayed.)

Checks/updates the firmware version. For details, consult your nearest Alpine dealer.

FW VERSION (firmware version)

Displays current firmware version.

FW UPDATE (firmware update)

Enters firmware update process: [YES], [NO].
Updating the firmware takes a few minutes to complete. During the update, do not turn the ignition to the OFF position, nor remove the USB device.

Audio Setup (AUDIO)

This setup menu is not available when the source is off and the clock is displayed.

EQ PRESET

Selects an equalizer curve from 10 equalizer curves or off:

[USER], [FLAT](OFF), [POPS], [ROCK], [NEWS], [JAZZ], [ELEC DANCE], [HIP HOP], [EASY LIS], [COUNTRY], [CLASSICAL].

The equalizer curve setting can be memorized for each source.

3BAND PEQ (3Band Parametric Equalizer)

Adjusts WIDTH, FREQUENCY and LEVEL for each after BAND is selected.

BAND: [BASS], [MID], [TREBLE].

Setting contents: [WIDTH <Q>], [CENTER FREQ], [LEVEL].

BALANCE

Adjusts the sound balance: [R 15] – [0] – [L 15].

FADER

Adjusts the relative level: [F 15] – [0] – [R 15].

SUBWOOFER (subwoofer)

SUBW LEVEL (subwoofer level)

Adjusts the subwoofer volume level:
[OFF], [0] - [+15].

SUBW PHASE (subwoofer phase)

Selects the subwoofer phase: [NORMAL], [REVERSE].

LPF FREQ (low pass filter frequency)

Selects the subwoofer cut-off frequency:
[80Hz], [100Hz], [120Hz].

HPF FREQ (high pass filter frequency)

Selects the front/rear speaker cut-off frequency: [OFF], [80Hz], [100Hz], [120Hz].

AUX VOL (AUX volume level)

Adjusts the volume level for each connected auxiliary device: [+18 dB] – [0 dB] – [-8 dB].

This setting negates the need to adjust the volume level between sources.

(Available only when the AUX is selected.)

BTA VOL (BLUETOOTH audio volume level) (CDE-175BT/ CDE-172BT/ UTE-73BT only)

Adjusts the volume level for each connected BLUETOOTH device: [+6 dB] – [0 dB] – [-6 dB].

This setting negates the need to adjust the volume level between sources.

(Available only when the BT audio or Pandora® is selected.)

Display Setup (DISPLAY)

BLACK OUT

If no operation is performed for a while with [ON] set, the display disappears automatically.

Activates the black out: [ON], [OFF].

DIMMER

Changes the display brightness:

For CDE-175BT/ CDE-172BT/UTE-73BT:
[OFF], [ON], [AUTO], [CLOCK].

([AUTO] is available only when the illumination control lead is connected, and the head light is turned on.)

For CDE-170: [OFF], [ON], [CLOCK].

To set this function to be active only during a fixed period, select [CLOCK], then set the start and end times.

– To set the brightness when the dimmer function is activated:

Set [DIMMER] to [ON], then adjust [BRIGHTNESS].

– To set the brightness when the dimmer function is deactivated:

Set [DIMMER] to [OFF], then adjust [BRIGHTNESS].

The brightness setting is stored and applied when the dimmer function is activated or deactivated.

BRIGHTNESS

Adjusts the display brightness. The brightness level is adjustable: [1] – [10].

KEY COLOR (CDE-175BT/ CDE-172BT/ UTE-73BT only)

Sets a preset color or customized color for the buttons.

OPTION

Selects from 10 presets colors, 1 customized color.

CUSTOMIZE

Registers a customized color for the buttons.

RGB RED, RGB GREEN, RGB BLUE

Adjustable color range: [0] – [32] ([0] cannot be set for all color ranges).

DISP COLOR (CDE-175BT/ CDE-172BT/ UTE-73BT only)

Sets a preset color or customized color for the display.

OPTION

Selects from 10 presets colors, 1 customized color.

CUSTOMIZE

Registers a customized color for the display.

RGB RED, RGB GREEN, RGB BLUE

Adjustable color range: [0] – [32] ([0] cannot be set for all color ranges).

TEXT SCROLL

Scrolls long items automatically: [ON], [OFF].
(Not available when the AUX or tuner is selected.)

BLUETOOTH Setup (BLUETOOTH) (CDE-175BT/ CDE-172BT/ UTE-73BT only)

PAIRING (page 11)

Connects up to two BLUETOOTH devices:
[DEVICE 1], [DEVICE 2].
[DEVICE 1] or [DEVICE 2] will be changed to the paired device name after pairing is complete.

AUDIO DEVICE

Selects the audio device.
[*] appears on the device paired with [DEVICE 1] or the current A2DP compatible audio device.

RINGTONE

Selects whether this unit or the connected cellular phone outputs the ringtone: [1] (this unit), [2] (cellular phone).

AUTO ANSWER

Sets this unit to answer an incoming call automatically: [OFF], [1] (about 3 seconds), [2] (about 10 seconds).

AUTO PAIR (auto pairing)

Starts BLUETOOTH pairing automatically when iOS device version 5.0 or later is connected via USB: [ON], [OFF].

BT IN (page 12)

Activates/deactivates the BLUETOOTH function.

BT INITIAL (BLUETOOTH initialize)

Initializes all the BLUETOOTH related settings (pairing information, preset number, device information, etc.): [YES], [NO].
When disposing the unit, initialize all the settings.
(Available only while the source is off and the clock is displayed.)

Additional Information

Updating the Firmware

To update the firmware, visit the Alpine website.
<http://www.alpine-usa.com>

Notes

- Using a USB device (not supplied) is required for updating the firmware. Store the updater in the USB device, and connect the device to the USB port, then perform the update operation.
- Updating the firmware takes a few minutes to complete. During the update, do not turn the ignition to the OFF position, nor remove the USB device.

Precautions

- Cool off the unit beforehand if your car has been parked in direct sunlight.
- Do not leave the front panel or audio devices brought in inside the car, or it may cause malfunction due to high temperature in direct sunlight.
- Power antenna (aerial) extends automatically.

Moisture condensation

Should moisture condensation occur inside the unit, remove the disc and wait for about an hour for it to dry out; otherwise the unit will not operate properly.

To maintain high sound quality

Do not splash liquid onto the unit or discs.

Notes on discs (CDE-175BT/ CDE-172BT/ CDE-170 only)

- Do not expose discs to direct sunlight or heat sources such as hot air ducts, nor leave it in a car parked in direct sunlight.
- Before playing, wipe the discs with a cleaning cloth from the center out. Do not use solvents such as benzine, thinner, commercially available cleaners.



- This unit is designed to play discs that conform to the Compact Disc (CD) standard. DualDiscs and some of the music discs encoded with copyright protection technologies do not conform to the Compact Disc (CD) standard, therefore, these discs may not be playable by this unit.
- Discs that this unit CANNOT play
 - Discs with labels, stickers, or sticky tape or paper attached. Doing so may cause a malfunction, or may ruin the disc.
 - Discs with non-standard shapes (e.g., heart, square, star). Attempting to do so may damage the unit.
 - 8 cm (3 1/4 in) discs.

Notes on CD-R/CD-RW discs

- If the multi-session disc begins with a CD-DA session, it is recognized as a CD-DA disc, and other sessions are not played.
- Discs that this unit CANNOT play
 - CD-R/CD-RW of poor recording quality.
 - CD-R/CD-RW recorded with an incompatible recording device.
 - CD-R/CD-RW which is finalized incorrectly.
 - CD-R/CD-RW other than those recorded in music CD format or MP3 format conforming to ISO9660 Level 1/Level 2, Joliet/Romeo or multi-session.

Playback order of audio files

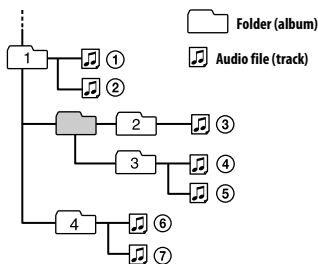

About iPod (CDE-175BT/ CDE-172BT/ UTE-73BT only)

- You can connect to the following iPod models. Update your iPod devices to the latest software before use.

Compatible iPhone/iPod models

Compatible Model	Bluetooth®	USB
iPhone 7	✓	✓
iPhone 7 Plus	✓	✓
iPhone SE	✓	✓
iPhone 6s	✓	✓
iPhone 6s Plus	✓	✓
iPhone 6	✓	✓
iPhone 6 Plus	✓	✓
iPhone 5s	✓	✓
iPhone 5c	✓	✓
iPhone 5	✓	✓
iPhone 4s	✓	✓
iPod touch (6th generation)	✓	✓
iPod touch (5th generation)	✓	✓
iPod nano (7th generation)		✓

- Use of the Made for Apple badge means that an accessory has been designed to connect specifically to the Apple product(s) identified in the badge, and has been certified by the developer to meet Apple performance standards. Apple is not responsible for the operation of this device or its compliance with safety and regulatory standards. Please note that the use of this accessory with an Apple product may affect wireless performance.

If you have any questions or problems concerning your unit that are not covered in this manual, consult your nearest Alpine dealer.

Maintenance

Cleaning the connectors

The unit may not function properly if the connectors between the unit and the front panel are not clean. In order to prevent this, detach the front panel (page 10) and clean the connectors with a cotton swab. Do not apply too much force. Otherwise, the connectors may be damaged.

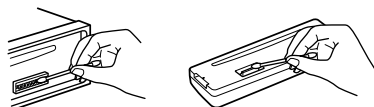

Notes

- For safety, turn off the ignition before cleaning the connectors, and remove the key from the ignition switch.
- Never touch the connectors directly with your fingers or with any metal device.

Specifications

FOR THE CUSTOMERS IN THE USA. NOT APPLICABLE IN CANADA, INCLUDING IN THE PROVINCE OF QUEBEC.

POUR LES CLIENTS AUX ÉTATS-UNIS. NON APPLICABLE AU CANADA, Y COMPRIS LA PROVINCE DE QUÉBEC.

AUDIO POWER SPECIFICATIONS



CTA2006 Standard
Power Output: 18 Watts RMS \times 4 at 4
Ohms < 1% THD+N
SN Ratio: 80 dBA
(reference: 1 Watt into 4 Ohms)

Tuner section

FM

Tuning range: 87.7 MHz – 107.9 MHz
Antenna (aerial) terminal:
External antenna (aerial) connector
Intermediate frequency:
FM CCIR: -1,956.5 kHz to -487.3 kHz and
+500.0 kHz to +2,095.4 kHz
Usable sensitivity: 8 dBf
Selectivity: 75 dB at 400 kHz
Signal-to-noise ratio: 73 dB
Separation: 50 dB at 1 kHz
Frequency response: 20 Hz – 15,000 Hz

AM

Tuning range: 530 kHz – 1,710 kHz
Antenna (aerial) terminal:
External antenna (aerial) connector
Sensitivity: 26 μ V

CD Player section (CDE-175BT/ CDE-172BT/ CDE-170 only)

Signal-to-noise ratio: 95 dB
Frequency response: 20 Hz – 20,000 Hz
Wow and flutter: Below measurable limit
Maximum number*¹ of:
Folders (albums)*²: 150
Files (tracks) and folders*³: 300
Displayable characters for a folder/ file name:
32 (Joliet)/64 (Romeo)
Corresponding codec: MP3 (.mp3), WMA (.wma)
and AAC (.m4a)*⁴

*¹ CD-R/CD-RW only
*² including the root folder
*³ may be less than the measured value if folder/
file names contain many characters
*⁴ CDE-175BT/ CDE-172BT only

USB Player section

Interface: USB (Full-speed)
Maximum current:
CDE-175BT/ CDE-172BT/ UTE-73BT: 1 A
CDE-170: 500 mA
The maximum number of recognizable tracks:
– folders (albums): 256
– files (tracks) per folder: 256
Compatible Android Open Accessory protocol
(AOA): 2.0
Corresponding codec:
MP3 (.mp3)
Bit rate: 8 kbps – 320 kbps (Supports VBR
(Variable Bit Rate))
Sampling rate: 16 kHz – 48 kHz
WMA (.wma)
Bit rate: 32 kbps – 192 kbps (Supports VBR
(Variable Bit Rate))
Sampling rate: 32 kHz, 44.1 kHz,
48 kHz
FLAC (.flac)
Bit depth: 16 bit, 24 bit
Sampling rate: 44.1 kHz, 48 kHz
AAC (.m4a) (CDE-175BT/ CDE-172BT/ UTE-
73BT only)
Bit rate: 8 kbps – 320 kbps
Sampling rate: 11.025 kHz – 48 kHz

Wireless Communication (CDE-175BT/ CDE-172BT/ UTE-73BT only)

Communication System:

BLUETOOTH Standard version 3.0

Output:

BLUETOOTH Standard Power Class 2
(Conducted MAX +1 dBm)

Maximum communication range:

Line of sight approx. 10 m (33 ft)*1

Frequency band:

2.4 GHz band
(2.4000 GHz – 2.4835 GHz)

Modulation method: FHSS

Compatible BLUETOOTH Profiles*2:

A2DP (Advanced Audio Distribution Profile)
1.3

AVRCP (Audio Video Remote Control Profile)
1.3

HFP (Handsfree Profile) 1.6

PBAP (Phone Book Access Profile)

SPP (Serial Port Profile)

Corresponding codec:

SBC (.sbc), AAC (.m4a)

*1 The actual range will vary depending on factors such as obstacles between devices, magnetic fields around a microwave oven, static electricity, reception sensitivity, antenna (aerial)'s performance, operating system, software application, etc.

*2 BLUETOOTH standard profiles indicate the purpose of BLUETOOTH communication between devices.

Power amplifier section

Output: Speaker outputs

Speaker impedance: 4 Ω – 8 Ω

Maximum power output: 50 W × 4 (at 4 Ω)

General

Outputs:

Audio outputs terminal:

CDE-175BT/ CDE-172BT/ UTE-73BT :
FRONT, REAR, SUB

CDE-170: FRONT, SUB

Power requirements: 12 V DC car battery
(negative ground (earth))

Rated current consumption: 10 A

Dimensions:

Approx. 178 mm × 50 mm × 177 mm
(7 1/8 in × 2 in × 7 in) (w/h/d)

Mounting dimensions:

Approx. 182 mm × 53 mm × 159 mm
(7 1/4 in × 2 1/8 in × 6 3/8 in) (w/h/d)

Mass:

CDE-175BT/ CDE-172BT/ CDE-170:

Approx. 1.2 kg (2 lb 11 oz)

UTE-73BT: Approx. 0.8 kg (1 lb 12 oz)

Package contents:

Main unit (1)

Microphone (1) (CDE-175BT/ CDE-172BT/
UTE-73BT only)

Parts for installation and connections (1 set)

Optional accessories/equipment:

SiriusXM Connect Vehicle Tuner: SXV100,
SXV200, SXV300 (CDE-175BT/ CDE-172BT
only)

Your dealer may not handle some of the above listed accessories. Please ask the dealer for detailed information.

Design and specifications are subject to change without notice.

Copyrights



SiriusXM Connect Vehicle Tuner and Subscription sold separately.

www.siriusxm.com

Sirius, XM and all related marks and logos are trademarks of Sirius XM Radio Inc. All rights reserved.

The Bluetooth® word mark and logos are registered trademarks owned by Bluetooth SIG, Inc. and any use of such marks by Alpine Electronics, Inc. is under license.

The N-Mark is a trademark or registered trademark of NFC Forum, Inc. in the United States and in other countries.

Windows Media and the Windows logo are trademarks, or registered trademarks of Microsoft Corporation in the United States and/ or other countries.

This product is protected by certain intellectual property rights of Microsoft Corporation. Use or distribution of such technology outside of this product is prohibited without a license from Microsoft or an authorized Microsoft subsidiary.

Apple, iPhone, iPod, iPod nano, iPod touch, and Siri are trademarks of Apple Inc., registered in the U.S. and other countries.
App Store is a service mark of Apple Inc.

MPEG Layer-3 audio coding technology and patents licensed from Fraunhofer IIS and Thomson.

Pandora®, the Pandora® logo, and the Pandora® trade dress are trademarks or registered trademarks of Pandora Media, Inc., used with permission. Pandora is currently available in the U.S. only.

Google, Google Play and Android are trademarks of Google LLC.

libFLAC

Copyright (C) 2000-2009 Josh Coalson
Copyright (C) 2011-2013 Xiph.Org Foundation

Redistribution and use in source and binary forms, with or without modification, are permitted provided that the following conditions are met:

- Redistributions of source code must retain the above copyright notice, this list of conditions and the following disclaimer.
- Redistributions in binary form must reproduce the above copyright notice, this list of conditions and the following disclaimer in the documentation and/or other materials provided with the distribution.
- Neither the name of the Xiph.org Foundation nor the names of its contributors may be used to endorse or promote products derived from this software without specific prior written permission.

THIS SOFTWARE IS PROVIDED BY THE COPYRIGHT HOLDERS AND CONTRIBUTORS "AS IS" AND ANY EXPRESS OR IMPLIED WARRANTIES, INCLUDING, BUT NOT LIMITED TO, THE IMPLIED WARRANTIES OF MERCHANTABILITY AND FITNESS FOR A PARTICULAR PURPOSE ARE DISCLAIMED. IN NO EVENT SHALL THE FOUNDATION OR CONTRIBUTORS BE LIABLE FOR ANY DIRECT, INDIRECT, INCIDENTAL, SPECIAL, EXEMPLARY, OR CONSEQUENTIAL DAMAGES (INCLUDING, BUT NOT LIMITED TO, PROCUREMENT OF SUBSTITUTE GOODS OR SERVICES; LOSS OF USE, DATA, OR PROFITS; OR BUSINESS INTERRUPTION) HOWEVER CAUSED AND ON ANY THEORY OF LIABILITY, WHETHER IN CONTRACT, STRICT LIABILITY, OR TORT (INCLUDING NEGLIGENCE OR OTHERWISE) ARISING IN ANY WAY OUT OF THE USE OF THIS SOFTWARE, EVEN IF ADVISED OF THE POSSIBILITY OF SUCH DAMAGE.

Troubleshooting

The following checklist will help you remedy problems you may encounter with your unit. Before going through the checklist below, check the connection and operating procedures. For details on using the fuse and removing the unit from the dashboard, see "Connection/Installation" (page 38). If the problem is not solved, please contact your authorized Alpine dealer for assistance.

General

No sound or the sound is very low.

- The position of the fader control [FADER] is not set for a 2-speaker system.
- The volume of the unit and/or connected device is very low.
 - Increase the volume of the unit and connected device.

No beep sound.

- An optional power amplifier is connected and you are not using the built-in amplifier.

The contents of the memory have been erased.

- The power supply lead or battery has been disconnected or not connected properly.

Stored stations and correct time are erased.

The fuse has blown.



Makes a noise when the position of the ignition is switched.

- The leads are not matched correctly with the car's accessory power connector.

During playback or reception, the demonstration mode starts.

- If no operation is performed for 5 minutes with [DEMO ON] set, the demonstration mode starts.
 - Set [DEMO OFF] (page 24).

The display disappears from/does not appear in the display window.

- The dimmer is set to [DIMMER ON] (page 25).
- The display disappears if you press and hold  (Power).
 - Press  (Power) on the unit until the display appears.
- The connectors are dirty (page 28).

The display/illumination flashes.

- The power supply is not sufficient.
 - Check that the car battery supplies enough power to the unit. (The power requirement is 12 V DC.)

The operation buttons do not function.

The disc will not eject.

- Press  and Number button 6 for more than 2 seconds to reset the unit.

The contents stored in memory are erased.

For your safety, do not reset the unit while you are driving.

Radio reception

Stations cannot be received.

The sound is hampered by noises.

- The connection is not correct.
 - Check the connection of the car antenna (aerial).
 - If the auto antenna (aerial) will not extend, check the connection of the power antenna (aerial) control lead.

Preset tuning is not possible.

- The broadcast signal is too weak.

RDS

PTY displays [- - - - -].

- The current station is not an RDS station.
- RDS data has not been received.
- The station does not specify the program type.

CD playback

The disc does not play.

- Defective or dirty disc.
- The CD-R/CD-RW is not for audio use (page 27).

MP3/WMA/AAC files cannot be played.

- The disc is incompatible with the MP3/WMA/AAC format and version.

MP3/WMA/AAC files take longer to play than others.

- The following discs take a longer time to start playback.
 - A disc recorded with a complicated tree structure.
 - A disc recorded in Multi Session.
 - A disc to which data can be added.

The sound skips.

- Defective or dirty disc.

USB device playback

You cannot play items via a USB hub.

- This unit cannot recognize USB devices via a USB hub.

A USB device takes longer to play.

- The USB device contains files with a complicated tree structure.

The sound is intermittent.

- The sound may be intermittent at a high-bit-rate.
- DRM (Digital Rights Management) files may not be playable in some cases.

The audio file cannot be played.

- USB devices formatted with file systems other than FAT16 or FAT32 are unsupported.*

* This unit supports FAT16 and FAT32, but some USB device may not support all of these FAT. For details, refer to the operating instruction of each USB device or contact the manufacturer.

Operations for skipping an album, skipping items (Jump mode), and searching a track by name cannot be performed.

- These operations cannot be performed when a USB device in Android mode or iPod is connected.
 - Set [USB MODE] to [MSC/MTP] (page 24).
 - Remove the iPod.
- The USB mode of the device is not set to the appropriate mode.
 - Make sure that the USB mode of the device is set to MSC/MTP mode.

The sound cannot be output during playback in Android mode.

- While the unit is in ANDROID mode, the sound outputs only from the Android smartphone.
 - Check the status of the audio playback application on the Android smartphone.
 - Playback may not perform properly depending on the Android smartphone.

NFC function**One touch connection (NFC) is not possible.**

- If the smartphone does not respond to the touching.
 - Check that the NFC function of the smartphone is turned on.
 - Move the N-Mark part of the smartphone closer to the N-Mark part on this unit.
 - If the smartphone is in a case, remove it.
- NFC receiving sensitivity depends on the device.

If One touch connection with the smartphone fails several times, make BLUETOOTH connection manually.

BLUETOOTH function**The connecting device cannot detect this unit.**

- Before the pairing is made, set this unit to pairing standby mode.
- While connected to two BLUETOOTH devices, this unit cannot be detected from another device.
 - Disconnect either connection and search for this unit from another device.
- When the device pairing is made, set the BLUETOOTH signal output to on (page 12).

Connection is not possible.

- The connection is controlled from one side (this unit or BLUETOOTH device), but not both.
 - Connect to this unit from a BLUETOOTH device or vice versa.

The name of the detected device does not appear.

- Depending on the status of the other device, it may not be possible to obtain the name.

No ringtone.

- Adjust the volume by rotating the control dial while receiving a call.
- Depending on the connecting device, the ringtone may not be sent properly.
 - Set [RINGTONE] to [1] (page 26).
- The front speakers are not connected to the unit.
 - Connect the front speakers to the unit. The ringtone is output only from the front speakers.

The talker's voice cannot be heard.

- The front speakers are not connected to the unit.
 - Connect the front speakers to the unit. The talker's voice is output only from the front speakers.

A call partner says that the volume is too low or high.

- Adjust the volume accordingly using Mic gain adjustment (page 21).

Echo or noise occurs in phone call conversations.

- Lower the volume.
- Set EC/NC Mode to [BTP EC/NC 1] or [BTP EC/NC 2] (page 21).
- If the ambient noise other than the phone call sound is loud, try reducing this noise. E.g.: If a window is open and road noise, etc., is loud, shut the window. If an air conditioner is loud, lower the air conditioner.

The phone is not connected.

- When BLUETOOTH audio is played, the phone is not connected even if you press .
 - Connect from the phone.

The phone sound quality is poor.

- Phone sound quality depends on reception conditions of cellular phone.
 - Move your car to a place where you can enhance the cellular phone's signal if the reception is poor.

The volume of the connected audio device is low (high).

- Volume level will differ depending on the audio device.
 - Adjust the volume of the connected audio device or this unit (page 25).

The sound skips during playback of a BLUETOOTH audio device.

- Reduce the distance between the unit and the BLUETOOTH audio device.
- If the BLUETOOTH audio device is stored in a case which interrupts the signal, remove the audio device from the case during use.
- Several BLUETOOTH devices or other devices which emit radio waves are in use nearby.
 - Turn off the other devices.
 - Increase the distance from the other devices.
- The playback sound stops momentarily when the connection between this unit and the cellular phone is being made. This is not a malfunction.

The connected BLUETOOTH audio device cannot be controlled.

- Check that the connected BLUETOOTH audio device supports AVRCP.

Some functions do not work.

- Check if the connecting device supports the functions in question.

A call is answered unintentionally.

- The connecting phone is set to answer a call automatically.

Pairing failed due to a timeout.

- Depending on the connecting device, the time limit for pairing may be short.
 - Try completing the pairing within the time.

BLUETOOTH function cannot operate.

- Turn off the unit by pressing ⏻ (Power) for more than 2 seconds, then turn the unit on again.

No sound is output from the car speakers during handsfree call.

- If the sound is output from the cellular phone, set the cellular phone to output the sound from the car speakers.

Siri Eyes Free is not activated.

- Perform the handsfree registration for an iPhone that supports Siri Eyes Free.
- Set the Siri function on the iPhone to on.
- Cancel the BLUETOOTH connection with the iPhone and the unit, and reconnect.

Pandora® operation**Pandora® connection is not possible.**

- Shut down the Pandora® application on the mobile device, and then launch it again.

Messages

The following messages may appear or flash during operation.

If these solutions do not help improve the situation, consult your nearest Alpine dealer. If you take the unit to be repaired because of CD playback trouble, bring the disc that was used at the time the problem began.

CD ERROR: The disc cannot be played. The disc will be ejected automatically.

→ Clean or insert the disc correctly, or make sure the disc is not blank or defective.

CD NO MUSIC: There is no playable file. The disc will be ejected automatically.

→ Insert a disc containing playable files (page 29).

CD PUSH EJT: The disc could not be ejected properly.

→ Press and hold  (eject).

HUB NO SUPRT: USB hubs are not supported.

INVALID

→ The selected operation could be invalid.
→ [USB MODE] cannot be changed during iPod playback.

IPD STOP: iPod playback has finished.

→ Operate your iPod/iPhone to start playback.

NOT SUPPORT - ANDROID MODE

→ A USB device not supporting AOA (Android Open Accessory) 2.0 is connected to the unit while [USB MODE] is set to [ANDROID].
– Set [USB MODE] to [MSC/MTP] (page 24).

OVERLOAD: The USB device is overloaded.

→ Disconnect the USB device, then press SOURCE  to select another source.
→ The USB device has a fault, or an unsupported device is connected.

READ: Now reading information.

→ Wait until reading is complete and playback starts automatically. This may take some time depending on the file organization.

USB ERROR: The USB device cannot be played.

→ Connect the USB device again.

USB NO DEV: A USB device is not connected or recognized.

→ Make sure the USB device or USB cable is securely connected.

USB NO MUSIC: There is no playable file.

→ Connect a USB device containing playable files (page 29).

USB NO SUPRT: The USB device is not supported.

→ For details on the compatibility of your USB device, consult your nearest Alpine dealer.

LLLL or ׀׀׀׀׀׀: The beginning or the end of the disc has been reached.

_ (underscore): The character cannot be displayed.

For BLUETOOTH function:

BTA NO DEV: The BLUETOOTH device is not connected or recognized.

→ Make sure the BLUETOOTH device is securely connected, or the BLUETOOTH connection is established with the BLUETOOTH device.

ERROR: The selected operation could not be performed.

→ Wait for a while, then try again.

UNKNOWN: A name or phone number cannot be displayed.

WITHHELD: The phone number is hidden by the caller.

For Pandora® operation:

PANDORA BOOKMARK ERROR: Bookmarking failed.

→ Wait for a while, then try again.

LOG IN ERROR: You are not logged into your Pandora® account.

→ Disconnect the device, log into your Pandora® account, then connect the device again.

PANDORA NO DEVICE: The BLUETOOTH device is not connected or recognized.

→ Make sure the BLUETOOTH device is securely connected, or the BLUETOOTH connection is established with the BLUETOOTH device. Then, select the Pandora® source again.

PANDORA NO STATIONS: No stations on your account.

→ Create the station on the mobile device.

NOT ALLOWED: The selected operation is not allowed.

→ "Thumbs" feedback is not allowed.

- Wait until the commercial ends.
- Some functions, such as Shared Station, do not permit feedback. Wait until the next track begins, or select another station on the list.

→ Bookmark is not allowed.

- Wait until the commercial ends.
 - Select another track or station, then try it again.
-

PANDORA UNAVAILABLE: Pandora® is not available outside your country or the selected station is no longer available or expired.

→ Select another station.

PANDORA ERROR: The selected operation could not be performed or the Pandora® server is under maintenance.

→ Wait for a while, then try again.

PANDORA NOT FOUND: Pandora® is not on your device or is not running.

→ Make sure the Pandora® application is installed and running properly. Then, select the Pandora® source again.

PANDORA BAD NETWORK: The network connection is unstable or lost.

→ Make the network connection again on the device, or wait until the network connection is established.

SKIP LIMIT: Skipping tracks is not allowed.

→ Wait until the commercial end, next track begins, or select another station on the list. Pandora® limits the number of skips allowed on their service.

THUMBS ERROR: "Thumbs" feedback failed.

→ Wait for a while, then try again.

PANDORA UPDATE APP: An old version of Pandora® is connected.

→ Update the Pandora® application to the latest version.

For SiriusXM operation:

CH LOCKED

→ The channel that you have requested is locked by the radio parental control feature. See "To set a parental control" (page 16) for more information on the parental control feature and how to access locked channels.

CH UNAVAIL

→ The channel that you have requested is not a valid SiriusXM channel or the channel that you were listening to is no longer available.

→ You may also see this message briefly when first connecting a new SiriusXM Connect Vehicle Tuner.

Visit www.siriusxm.com in the USA or www.siriusxm.ca in Canada for SiriusXM channel lineup information.

CHAN UNSUB

- The channel that you have requested is not included in your SiriusXM subscription package or the channel that you were listening to is no longer included in your SiriusXM subscription package.
If you have questions about your subscription package or would like to subscribe to this channel, please contact SiriusXM.
In the USA, visit www.siriusxm.com or call 1-866-635-2349.
In Canada, visit www.siriusxm.ca or call 1-877-438-9677.

CHK ANT

- The radio has detected a fault with the SiriusXM antenna.
- The antenna cable may be either disconnected or damaged.
 - Verify that the antenna cable is connected to the SiriusXM Connect Vehicle Tuner.
 - Inspect the antenna cable for damage and kinks.
 - Replace the antenna if the cable is damaged. SiriusXM products are available at your local car audio retailer or online at www.shop.siriusxm.com

CHECK TUNER

- The radio is having difficulty communicating with the SiriusXM Connect Vehicle Tuner.
- The tuner may be disconnected or damaged.
 - Verify that the SiriusXM Connect Vehicle Tuner cable is securely connected to the radio.

NO SIGNAL

- SiriusXM Connect Vehicle Tuner is having difficulty receiving the SiriusXM satellite signal.
 - Verify that your vehicle is outdoors with a clear view of the sky.
 - Verify that the SiriusXM magnetic mount antenna is mounted on a metal surface on the outside of the vehicle.
 - Move the SiriusXM antenna away from any obstructions.
 - Inspect the antenna cable for damage and kinks.
 - Consult the SiriusXM Connect Vehicle Tuner installation manual for more information on antenna installation.

- Replace the antenna if the cable is damaged. SiriusXM products are available at your local car audio retailer or online at www.shop.siriusxm.com

SUBSCRIPTION UPDATED - PRESS ENT TO CONTINUE

- The radio has detected a change in your SiriusXM subscription status.
 - Press ENTER to clear the message.
If you have questions about your subscription, please contact SiriusXM.
In the USA, visit www.siriusxm.com or call 1-866-635-2349.
In Canada, visit www.siriusxm.ca or call 1-877-438-9677.

Connection/Installation

Cautions

- Run all ground (earth) leads to a common ground (earth) point.
- Do not get the leads trapped under a screw, or caught in moving parts (e.g., seat railing).
- Before making connections, turn the car ignition off to avoid short circuits.
- Connect the **yellow** and **red** power supply leads only after all other leads have been connected.
- Be sure to insulate any loose unconnected leads with electrical tape for safety.

Precautions

- Choose the installation location carefully so that the unit will not interfere with normal driving operations.
- Avoid installing the unit in areas subject to dust, dirt, excessive vibration, or high temperature, such as in direct sunlight or near heater ducts.
- Use only the supplied mounting hardware for a safe and secure installation.

Note on the power supply lead (yellow)

When connecting this unit in combination with other stereo components, the amperage rating of the car circuit to which the unit is connected must be higher than the sum of each component's fuse amperage rating.

Mounting angle adjustment

Adjust the mounting angle to less than 30°.

Parts List for Installation

1

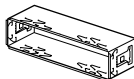

2



3

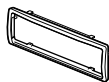

4

5 × max. 8 mm
(1/32 × max. 5/16 in)



5



For CDE-175BT/ CDE-172BT/ UTE-73BT

6

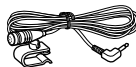

7



- This parts list does not include all the package contents.
- The bracket **1** and the protection collar **3** are attached to the unit before shipping. Before mounting the unit, use the release keys **2** to remove the bracket **1** from the unit. For details, see "Removing the protection collar and the bracket" (page 43).
- Keep the release keys **2** for future use as they are also necessary if you remove the unit from your car.

Connection

■ CDE-175BT/ CDE-172BT/ UTE-73BT

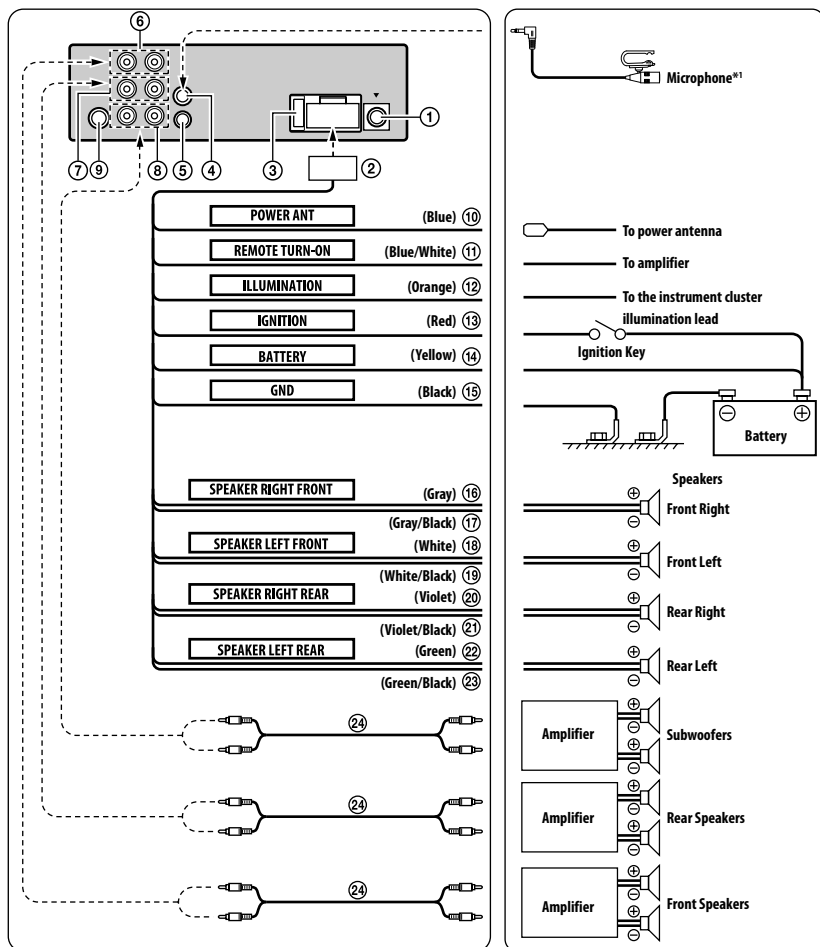

*1 Whether in use or not, route the microphone input cord such that it does not interfere with driving operations. Secure the cord with a clamp, etc., if it is installed around your feet. For details on installing the microphone, see "Installing the microphone (CDE-175BT/ CDE-172BT/ UTE-73BT only)" (page 42).

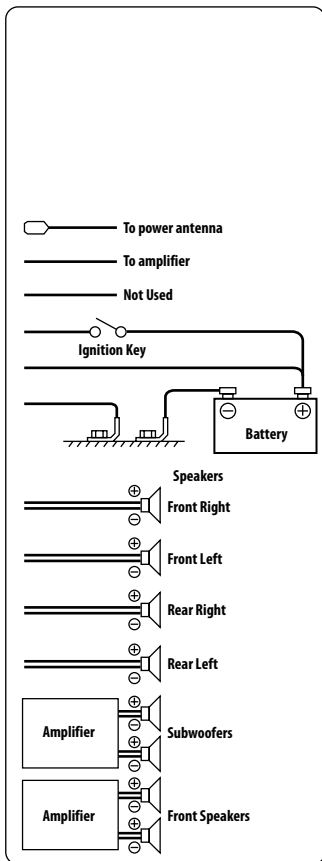
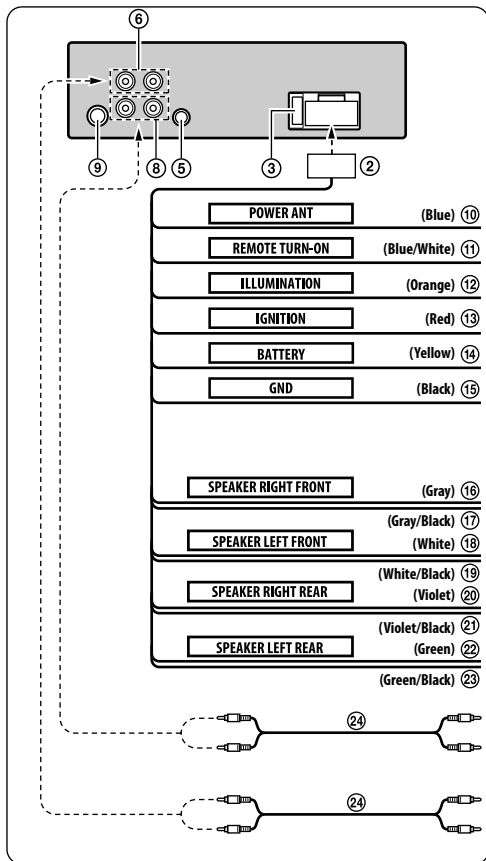

① **SiriusXM Tuner connector (CDE-175BT/ CDE-172BT only)**

Connect to SiriusXM Tuner.

- For more information on how to install the SiriusXM Connect Vehicle tuner, consult the installation guide included with the tuner.

② **Power Supply Connector**

③ **Fuse Holder (10A)**

Fuse replacement:

When replacing the fuse, be sure to use one matching the amperage rating stated on the original fuse. If the fuse blows, check the power connection and replace the fuse. If the fuse blows again after replacement, there may be an internal malfunction. In such a case, consult your nearest Alpine dealer.

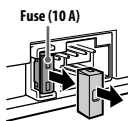

④ **MIC Input Connector (CDE-175BT/ CDE-172BT/ UTE-73BT only)**

To Microphone.

⑤ **Steering Remote Control Interface Connector**

To steering remote control interface box. You can operate this unit from the vehicle's control unit when an Alpine Steering Remote Control Interface Box (optional) is connected. For details, contact your Alpine dealer.

⑥ **Front Output RCA Connectors**

RED is right and WHITE is left.

⑦ **Rear Output RCA Connectors (CDE-175BT/ CDE-172BT/ UTE-73BT only)**

RED is right and WHITE is left.

⑧ **Subwoofer Output RCA Connectors**

⑨ **Antenna Receptacle**

⑩ **Power Antenna Lead (Blue)**

Connect this lead to the +B terminal of your power antenna, if applicable.

- This lead should be used only for controlling the vehicle's power antenna. Do not use this lead to turn on an amplifier or a signal processor, etc.

⑪ **Remote Turn-On Lead (Blue/White)**

Connect this lead to the remote turn-on lead of your amplifier or signal processor.

⑫ **Illumination Lead (Orange) (CDE-175BT/ CDE-172BT/ UTE-73BT only)**

This lead may be connected to the vehicle's instrument cluster illumination lead. This will enable the vehicle's dimmer control to dim the backlighting of the unit.

⑬ **Switched Power Lead (Ignition) (Red)**

Connect this lead to an open terminal on the vehicle's fuse box or another unused power source which provides (+) 12V only when the ignition is turned on or in the accessory position.

⑭ **Battery Lead (Yellow)**

Connect this lead to the positive (+) post of the vehicle's battery.

⑮ **Ground Lead (Black)**

Connect this lead to a good chassis ground on the vehicle. Make sure the connection is made to bare metal and is securely fastened using the sheet metal screw provided.

⑯ **Right Front (+) Speaker Output Lead (Gray)**

⑰ **Right Front (-) Speaker Output Lead (Gray/ Black)**

⑱ **Left Front (+) Speaker Output Lead (White)**

⑲ **Left Front (-) Speaker Output Lead (White/ Black)**

⑳ **Right Rear (+) Speaker Output Lead (Violet)**

㉑ **Right Rear (-) Speaker Output Lead (Violet/Black)**

㉒ **Left Rear (+) Speaker Output Lead (Green)**

㉓ **Left Rear (-) Speaker Output Lead (Green/ Black)**

㉔ **RCA Extension Cable (not supplied)**

To prevent external noise from entering the audio system.

- Locate the unit and route the leads at least 10 cm away from the car harness.
- Keep the battery power leads as far away from other leads as possible.
- Connect the ground lead securely to a bare metal spot (remove any paint, dirt or grease if necessary) of the car chassis.
- If you add an optional noise suppressor, connect it as far away from the unit as possible. Your Alpine dealer carries various noise suppressors, contact them for further information.
- Your Alpine dealer knows best about noise prevention measures so consult your dealer for further information.

Installing the microphone (CDE-175BT/ CDE-172BT/ UTE-73BT only)

To capture your voice during handsfree calling, you need to install the microphone ⑥.

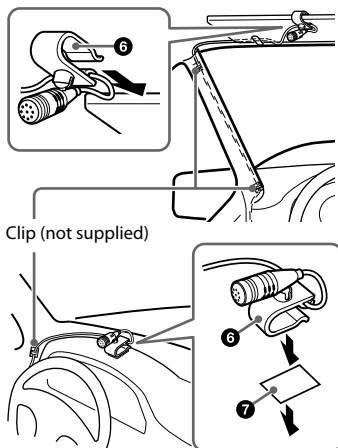

Cautions

- It is extremely dangerous if the cord becomes wound around the steering column or gearshift. Be sure to keep it and other parts from interfering with your driving operations.
- If airbags or any other shock-absorbing equipment is in your car, contact the store where you purchased this unit, or the car dealer, before installation.

Note

Before attaching the double-sided tape ⑦, clean the surface of the dashboard with a dry cloth.

Installation

Removing the protection collar and the bracket

Before installing the unit, remove the protection collar ③ and the bracket ① from the unit.

- 1 Pinch both edges of the protection collar ③, then pull it out.

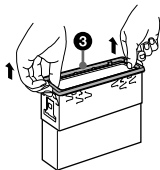

- 2 Insert both release keys ② until they click, and pull down the bracket ①, then pull up the unit to separate.

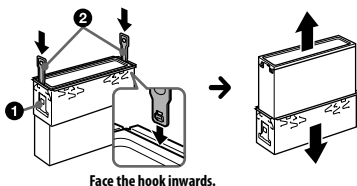

Mounting the unit in the dashboard

- Before installing, make sure the catches on both sides of the bracket ① are bent inwards 2 mm (3/32 in).
- For Japanese cars, see "Mounting the unit in a Japanese car" (page 43).

- 1 Position the bracket ① inside the dashboard, then bend the claws outward for a tight fit.

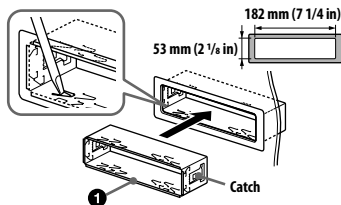

- 2 Mount the unit onto the bracket ①, then attach the protection collar ③.

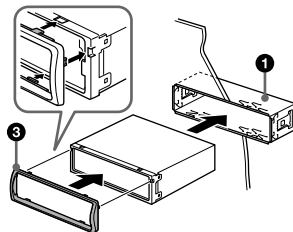

Notes

- If the catches are straight or bent outwards, the unit will not be installed securely and may spring out.
- Make sure the 4 catches on the protection collar ③ are properly engaged in the slots of the unit.

Mounting the unit in a Japanese car

You may not be able to install this unit in some makes of Japanese cars. In such a case, consult your Alpine dealer.

TOYOTA

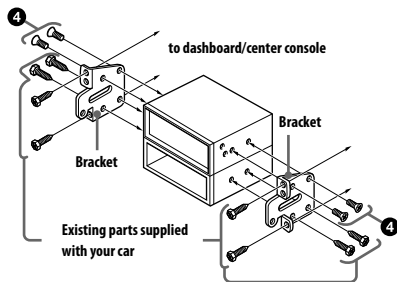

NISSAN

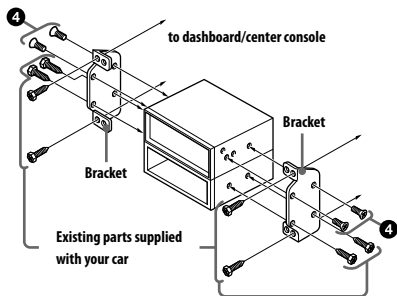

Note

To prevent malfunction, install only with the supplied screws 4.

Detaching and attaching the front panel

For details, see "Detaching the Front Panel" (page 10).

Resetting the unit

For details, see "Resetting the Unit" (page 10).

About the Rules of Bluetooth Electromagnetic Radiation Regulation

USA/Canada	<p>FCC/IC CAUTION</p> <p>Changes or modifications not expressly approved by the party responsible for compliance could void the user's authority to operate the equipment. This device complies with Part 15 of FCC Rules and Industry Canada licence-exempt RSS standard(s). Operation is subject to the following two conditions: (1) this device may not cause interference, and (2) this device must accept any interference, including interference that may cause undesired operation of this device.</p> <p>Le présent appareil est conforme aux la partie 15 des règles de la FCC et CNR d'Industrie Canada applicables aux appareils radio exempts de licence. L'exploitation est autorisée aux deux conditions suivantes : (1) l'appareil ne doit pas produire de brouillage, et (2) l'utilisateur de l'appareil doit accepter tout brouillage radioélectrique subi, même si le brouillage est susceptible d'en compromettre le fonctionnement.</p> <p>This equipment complies with FCC/IC radiation exposure limits set forth for an uncontrolled environment and meets the FCC radio frequency (RF) Exposure Guidelines in Supplement C to OET65 and RSS-102 of the IC radio frequency (RF) Exposure rules. This equipment has very low levels of RF energy that it deemed to comply without maximum permissive exposure evaluation (MPE). But it is desirable that it should be installed and operated keeping the radiator at least 20cm or more away from person's body (excluding extremities: hands, wrists, feet and ankles).</p> <p>Cet équipement est conforme aux limites d'exposition aux rayonnements énoncées pour un environnement non contrôlé et respecte les règles les radioélectriques (RF) de la FCC lignes directrices d'exposition dans le Supplément C à OET65 et d'exposition aux fréquences radioélectriques (RF) CNR-102 de l'IC. Cet équipement émet une énergie RF très faible qui est considérée conforme sans évaluation de l'exposition maximale autorisée. Cependant, cet équipement doit être installé et utilisé en gardant une distance de 20 cm ou plus entre le dispositif rayonnant et le corps (à l'exception des extrémités : mains, poignets, pieds et chevilles).</p>
México	<p>La operación de este equipo está sujeta a las siguientes dos condiciones: (1) es posible que este equipo o dispositivo no cause interferencia perjudicial y (2) este equipo o dispositivo debe aceptar cualquier interferencia, incluyendo la que pueda causar su operación no deseada.</p>



LIMITED WARRANTY

ALPINE ELECTRONICS OF AMERICA, INC. ("Alpine"), is dedicated to quality craftsmanship and are pleased to offer this Warranty. We suggest that you read it thoroughly. Should you have any questions, please contact your Dealer or contact Alpine at one of the telephone numbers listed below.

● PRODUCTS COVERED:

This Warranty covers Car Audio Products and Related Accessories ("the product"). Products purchased in the Canada are covered only in the Canada. Products purchased in the U.S.A. are covered only in the U.S.A.

● LENGTH OF WARRANTY:

This Warranty is in effect for one year from the date of the first consumer purchase.

● WHO IS COVERED:

This Warranty only covers the original purchaser of the product, who must reside in the United States, Puerto Rico or Canada.

● WHAT IS COVERED:

This Warranty covers defects in materials or workmanship (parts and labor) in the product.

● WHAT IS NOT COVERED:

This Warranty does not cover the following:

- ① Damage occurring during shipment of the product to Alpine for repair (claims must be presented to the carrier).
- ② Damage caused by accident or abuse, including burned voice coils caused by over-driving the speaker (amplifier level is turned up and driven into distortion or clipping). Speaker mechanical failure (e.g. punctures, tears or rips). Cracked or damaged LCD panels. Dropped or damaged hard drives.
- ③ Damage caused by negligence, misuse, improper operation or failure to follow instructions contained in the Owner's manual.
- ④ Damage caused by act of God, including without limitation, earthquake, fire, flood, storms or other acts of nature. Any cost or expense related to the removal or reinstallation of the product.
- ⑤ Service performed by an unauthorized person, company or association.
- ⑥ Any product which has the serial number defaced, altered or removed.
- ⑦ Any product which has been adjusted, altered or modified without Alpine's consent.
- ⑧ Any product not distributed by Alpine within the United States, Puerto Rico or Canada.
- ⑨ Any product not purchased from an Authorized Alpine Dealer.

● HOW TO OBTAIN WARRANTY SERVICE:

- ① You are responsible for delivery of the product to an Authorized Alpine Service Center or Alpine for repair and for payment of any initial shipping charges. Alpine will, at its option, repair or replace the product with a new or reconditioned product without charge. If the repairs are covered by the warranty, and if the product was shipped to an Authorized Alpine Service Center or Alpine, Alpine will pay the return shipping charges.
- ② You should provide a detailed description of the problem(s) for which service is required.
- ③ You must supply proof of your purchase of the product.

- ④ You must package the product securely to avoid damage during shipment. To prevent lost packages it is recommended to use a carrier that provides a tracking service.

● HOW WE LIMIT IMPLIED WARRANTIES:

ANY IMPLIED WARRANTIES INCLUDING FITNESS FOR USE AND MERCHANTABILITY ARE LIMITED IN DURATION TO THE PERIOD OF THE EXPRESS WARRANTY SET FORTH ABOVE AND NO PERSON IS AUTHORIZED TO ASSUME FOR ALPINE ANY OTHER LIABILITY IN CONNECTION WITH THE SALE OF THE PRODUCT.

● HOW WE EXCLUDE CERTAIN DAMAGES:

ALPINE EXPRESSLY DISCLAIMS LIABILITY FOR INCIDENTAL AND CONSEQUENTIAL DAMAGES CAUSED BY THE PRODUCT. THE TERM "INCIDENTAL DAMAGES" REFERS TO EXPENSES OF TRANSPORTING THE PRODUCT TO THE ALPINE SERVICE CENTER, LOSS OF THE ORIGINAL PURCHASER'S TIME, LOSS OF THE USE OF THE PRODUCT, BUS FARES, CAR RENTALS OR OTHERS COSTS RELATING TO THE CARE AND CUSTODY OF THE PRODUCT. THE TERM "CONSEQUENTIAL DAMAGES" REFERS TO THE COST OF REPAIRING OR REPLACING OTHER PROPERTY WHICH IS DAMAGED WHEN THIS PRODUCT DOES NOT WORK PROPERLY. THE REMEDIES PROVIDED UNDER THIS WARRANTY ARE EXCLUSIVE AND IN LIEU OF ALL OTHERS.

● HOW STATE/PROVINCIAL LAW RELATES TO THE WARRANTY:

This Warranty gives you specific legal rights, and you may also have other rights which vary from state to state and province to province. In addition, some states/provinces do not allow limitations on how long an implied warranty lasts, and some do not allow the exclusion or limitation of incidental or consequential damages. Accordingly, limitations as to these matters contained herein may not apply to you.

● IN CANADA ONLY:

This Warranty is not valid unless your Alpine car audio product has been installed in your vehicle by an Authorized Installation Center, and this warranty stamped upon installation by the installation center.

● HOW TO CONTACT CUSTOMER SERVICE:

Should the product require service, please call the following number for your nearest Authorized Alpine Service Center.

CAR AUDIO: 1-800-ALPINE-1 (1-800-257-4631)

NAVIGATION: 1-888-NAV-HELP (1-888-628-4357)

Or visit our website at: <http://www.alpine-usa.com>

ALPINE ELECTRONICS OF AMERICA, INC., 19145 Gramercy Place, Torrance, California 90501, U.S.A.

Do not send products to these addresses.

Call the toll free telephone number or visit the website to locate a service center.

Fidèle à son engagement de ne fournir que des produits de qualité, ALPINE ÉLECTRONIQUE DE L'AMÉRIQUE, INC. (« Alpine ») est heureuse de vous offrir cette garantie. Nous vous suggérons de la lire attentivement et en entier. Si vous avez la moindre question, veuillez contacter l'un de nos concessionnaires ou appeler directement Alpine aux numéros listés ci-dessous.

● PRODUITS COUVERTS PAR LA GARANTIE

Cette garantie couvre les produits audio de voiture et les accessoires connexes (« le produit »). Elle ne couvre les produits que dans le pays où ils ont été achetés.

● DURÉE DE LA GARANTIE

Cette garantie est en vigueur pendant un an à partir de la date du premier achat du client.

● PERSONNES PROTÉGÉES PAR LA GARANTIE

Seul l'acheteur original du produit, s'il réside aux États-Unis, à Porto Rico ou au Canada, peut se prévaloir de la garantie.

● CE QUI EST COUVERT

Cette garantie couvre tous les défauts de matériaux et de fabrication (pièces et main d'œuvre) du produit.

● CE QUI N'EST PAS COUVERT

Cette garantie ne couvre pas ce qui suit:

- ① Les dommages survenus durant le transport des produits renvoyés à Alpine pour être réparés (les réclamations doivent être adressées au transporteur);
- ② Les dégâts provoqués par un accident ou une mauvaise utilisation, y compris des bobines acoustiques grillées suite à une surexcitation des enceintes (augmentation du niveau de l'amplificateur jusqu'à atteindre un effet de distorsion ou d'écrêtage), une défaillance mécanique des enceintes (perforations, déchirures ou fentes), panneaux LCD fissurés ou endommagés, disques durs endommagés ou ayant subi une chute.
- ③ Tout dégât provoqué par négligence, usage inapproprié, mauvaise utilisation ou par le non-respect des instructions indiquées dans le manuel de l'utilisateur.
- ④ Les dommages dus à la force majeure, notamment aux tremblements de terre, au feu, aux inondations, aux tempêtes ou aux autres cataclysmes naturels;
Les frais ou les dépenses relatifs à l'enlèvement ou à la réinstallation du produit;
- ⑤ Les services rendus par une personne, physique ou morale non autorisée;
- ⑥ Les produits dont le numéro de série a été effacé, modifié ou retiré;
- ⑦ Les produits qui ont été adaptés ou modifiés sans le consentement d'Alpine;
- ⑧ Les produits qui ne sont pas distribués par Alpine aux États-Unis, à Porto Rico ou au Canada;
- ⑨ Les produits qui n'ont pas été achetés par l'entremise d'un concessionnaire Alpine autorisé;

● COMMENT SE PRÉVALOIR DE LA GARANTIE

- ① Il vous faut remettre le produit nécessitant des réparations à un centre de service autorisé Alpine ou à Alpine même et en assumer les frais de transport. Alpine a le choix entre réparer le produit ou le remplacer par un produit neuf ou révisé, le tout sans frais pour vous. Si les réparations sont couvertes par la garantie et si le produit a été envoyé à un centre de service Alpine ou à Alpine, le paiement des frais de réexpédition du produit incombe Alpine.

- ② Vous devez donner une description détaillée des problèmes qui sont à l'origine de votre demande de réparation.
- ③ Vous devez joindre la preuve de votre achat du produit.
- ④ Vous devez emballer soigneusement le produit pour éviter tout dommage durant son transport. Pour éviter la perte de l'envoi, il est conseillé de choisir un transporteur qui propose un service de suivi des envois.

● LIMITATION DES GARANTIES TACITES

LA DURÉE DE TOUTES LES GARANTIES TACITES, Y COMPRIS LA GARANTIE D'ADAPTATION À L'UTILISATION ET LA GARANTIE DE QUALITÉ LOYALE ET MARCHANDE, EST LIMITÉE À CELLE DE LA GARANTIE EXPRESSE DÉTERMINÉE CI-DESSUS. PERSONNE N'EST AUTORISÉ À ENGAGER AUTREMENT LA RESPONSABILITÉ D'ALPINE EN VERTU DE LA VENTE D'UN PRODUIT.

● EXCLUSIONS DE LA GARANTIE

ALPINE STIPULE EXPRESSÉMENT QU'ELLE N'EST PAS RESPONSABLE DES DOMMAGES-INTÉRÊTS ET DOMMAGES INDIRECTS PROVOQUÉS PAR LE PRODUIT. LES DOMMAGES-INTÉRÊTS SONT LES FRAIS DE TRANSPORT DU PRODUIT VERS UN CENTRE DE SERVICE ALPINE, LA PERTE DE TEMPS DE L'ACHETEUR ORIGINAL, LA PERTE D'UTILISATION DU PRODUIT, LES BILLETS D'AUTOBUS, LA LOCATION DE VOITURES ET TOUTS LES AUTRES FRAIS LIÉS À LA GARDE DU PRODUIT.

LES DOMMAGES INDIRECTS SONT LES FRAIS DE RÉPARATION OU DE REMPLACEMENT D'AUTRES BIENS ENDOMMAGÉS SUITE AU MAUVAIS FONCTIONNEMENT DU PRODUIT.

LES RECOURS PRÉVUS PAR LES PRÉSENTES EXCLUENT ET REMPLACENT TOUTE AUTRE FORME DE RECOURS.

● LIEN ENTRE LA GARANTIE ET LA LOI

La garantie vous donne des droits spécifiques, mais vous pouvez aussi jouir d'autres droits, qui varient d'un état ou d'une province à l'autre. En outre, certains états et certaines provinces interdisent de limiter la durée des garanties tacites ou d'exclure les dommages accessoires ou indirects. Dans ce cas, les limites et les exclusions de la garantie peuvent ne pas s'appliquer à vous.

● CLAUSE APPLICABLE AU CANADA SEULEMENT

Pour que la garantie soit valable, il faut qu'un centre d'installation autorisé ait installé le système audio pour l'auto dans votre véhicule et qu'il ait ensuite apposé son cachet sur la garantie.

● NUMÉROS D'APPEL DU SERVICE À LA CLIENTÈLE

Si vous avez besoin de nos services, veuillez appeler Alpine aux numéros ci-dessous pour le centre de service autorisé Alpine le plus proche.

AUDIO DE VOITURE : 1-800-ALPINE-1 (1-800-257-4631)
NAVIGATION : 1-888-NAV-HELP (1-888-628-4357)

Ou visitez notre site Web à l'adresse <http://www.alpine-usa.com>



(CDE-175BT)

(CDE-175BT/CDE-172BT)

pandora®



(CDE-175BT/CDE-172BT/UTE-73BT)

(CDE-175BT/CDE-172BT/UTE-73BT)



(CDE-175BT/CDE-172BT/UTE-73BT)

(CDE-175BT/ CDE-172BT/CDE-170)

Don't forget to take a moment to protect your purchase by registering your product now at the following address: www.alpine-usa.com/registration.

N'oubliez pas de consacrer un moment à la protection de votre achat en enregistrant votre produit dès maintenant à l'adresse suivante : www.alpine-usa.com/registration.

Recuerde que con solo unos pocos pasos podrá proteger su producto, registrándolo a través de la siguiente dirección: www.alpine-usa.com/registration.