



EN

FR

ES

7-INCH AUDIO/VIDEO RECEIVER

iLX-407

- OWNER'S MANUAL
Please read before using this equipment.
- MODE D'EMPLOI
Veuillez lire avant d'utiliser cet appareil.
- MANUAL DE OPERACIÓN
Léalo antes de utilizar este equipo.

Thank you for purchasing this Alpine product. Please take a moment to protect your purchase by registering your product now at the following address: www.alpine-usa.com/registration.
You will be informed of product and software updates (if applicable), special promotions, news about Alpine.

Merci d'avoir acheté ce produit Alpine. Nous vous invitons à consacrer un moment à la protection de votre achat en enregistrant votre produit dès maintenant à l'adresse suivante : www.alpine-usa.com/registration.
Vous serez tenu informé des mises à jour des produits et des logiciels (le cas échéant), des promotions spéciales et de l'actualité d'Alpine.

Gracias por adquirir este producto Alpine. Con solo unos pocos pasos podrá proteger su producto, registrándolo a través de la siguiente dirección: www.alpine-usa.com/registration.
Recibirá información sobre nuevos productos y software, promociones especiales y novedades sobre Alpine.

ALPINE ELECTRONICS OF AMERICA, INC.

1500 Atlantic Blvd,
Auburn Hills, Michigan 48326, U.S.A.
Phone 1-800-ALPINE-1 (1-800-257-4631)

ALPINE ELECTRONICS OF AUSTRALIA PTY. LIMITED

161-165 Princes Highway,
Hallam Victoria 3803, Australia
Phone 03-8787-1200

ALPS ALPINE EUROPE GMBH

Ohmstrasse 4, 85716 Unterschleissheim, Germany
Phone: +49 (0) 89-32 42 640
For contact information on your respective country,
please visit www.alpine-europe.com.

ALPS ALPINE ASIA CO., LTD.

The 9th Towers, Tower B, 24th Floor, Unit TNB01-03,
33/4 Rama 9 road, Huay Kwang, Bangkok, 10310, Thailand
Phone +66 (2) 090 9596



MX



SiriusXM
READY

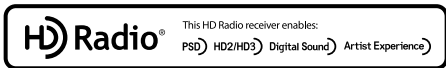

DATA LINK
maestro



HDMI
HIGH-DEFINITION MULTIMEDIA INTERFACE



CONTENTS

Operating Instructions

PRECAUTIONS

IMPORTANT INFORMATION	6
-----------------------------	---

WARNING

Points to Observe for Safe Usage	6
WARNING	6
CAUTION	7
NOTICE	8

Getting Started

Location of Controls	10
Turning Power On or Off.....	10
Adjusting the Volume	10
Lowering Volume Quickly	10
Touch Screen Operation	11
Switching Sources.....	11
Selecting an Item in a List	11
About the HOME Screen.....	12
Editing HOME screen	12
About the Indicator Display	13

Setup

Setup Operation	13
-----------------------	----

General Setup

Radio Setup	14
Setting the TUNER (FM) Tone Quality (Tuner Condition)	15
Setting the TUNER (FM) Frequency Step	15
Setting the Ballgame Mode.....	15
SiriusXM Setup.....	15
Setting the Parental Lock	15
Signal Strength Information	16
AUX Setup.....	16
Setting the AUX Select	16
Setting the Input Signal.....	16
Setting the Display Mode.....	16
Language Setup	16
Wallpaper Setup	17

Setting a Wallpaper using a default image.....	17
Setting a Wallpaper using your image	17
Screen/LED Customize Setup	17
Setting the Brightness of the Backlighting (Dimmer).....	17
Adjusting the Minimum Level of Backlight ...	17
Adjusting the Dimmer of Button Lighting at Night.....	18
Date/Clock Setup	18
Display Off Setting	18
About iLX-407.....	18
Displaying the Product Information.....	18
Displaying Warranty/Copyright Information...	18
Initializing the System	18
Installation Setup	19
Steering Wheel Position Setting	19
Mute Setting	19
iDataLink Setting	19
Setting the Default Vehicle Screen	19
Setting the Parking Assist Enable.....	19
Setting the Maestro Module	19

Connection (Bluetooth) Setup

Displaying Bluetooth Information	20
Pairing the Bluetooth Device	20
Setting the Bluetooth Device	20
Deleting a Bluetooth Device from the list.....	20
Apple CarPlay Setup.....	21

Camera Setup

Rear Camera Setup	21
Camera Input Setting	21
Camera Signal Input Setting.....	21
Rear Camera Guide Settings	22
Camera Picture Quality Setup	22
Camera Interrupt Setting (DISPLAY OFF Mode).....	22
Front Camera Setup	23
Camera Input Setting	23
Camera Signal Input Setting.....	23
Camera Picture Quality Setup	23

Sound Setup

Setting the Media Xpander (MX).....	24
Equalizer Settings.....	24

Fader/Balance/Bass/Treble/Subwoofer	
Settings.....	24
Setting the Fader/Balance	25
Adjusting the Bass/Treble	25
Setting the Subwoofer	25
Graphic Equalizer Curve Settings (Graphic EQ).....	25
Time Correction Settings.....	26
Crossover Settings (X-Over).....	26
Volume Setup	27
Adjusting the Key Sound.....	27
Adjusting the Source Volume	27
Setting the Volume for Android Auto™.....	27
Setting the Volume for Apple CarPlay	27
Adjusting the Volume for Phone	27
Turning Subwoofer ON/OFF.....	27
Rear Speaker Setting.....	28
Defeat Setting.....	28
About the Crossover	28
About Time Correction.....	29

Apple CarPlay (Optional)

Access to Apple CarPlay	31
-------------------------------	----

Android Auto (Optional)

What is Android Auto	31
Activate Android Auto.....	31

Radio/HD Radio™/RBDS

Radio Basic Operation

Listening to the Radio	32
Presetting Stations Manually	33
Presetting Stations Automatically.....	33
Tuning to Preset Station	33
Receiving a Multicast (HD Radio™ Mode only).....	33
Forced Analog Mode.....	33
Selecting the Receivable Program Type (RBDS FM Radio Mode only)	33
Using Ballgame Mode (HD Radio™ Mode only)	34
Displaying Radio Text (HD Radio™/ RBDS FM Radio mode only)	34
About the Feature Logos.....	34

USB Flash drive (Optional)

USB Audio

Playback.....	35
Repeat Play.....	35
Shuffle Play.....	36

Searching for a Desired Song.....	36
-----------------------------------	----

USB Video

Fast-forwarding/Fast-reversing.....	37
Stopping Playback.....	37
Repeat Play	37
Searching for a Desired file.....	37
Setting the Brightness and Contrast	37
Displaying the Subtitle.....	37

USB Photo

Playback.....	38
Slide Show	38
Setting a Wallpaper with a Photo.....	38

iPod mode on iPhone (Optional)

Playback.....	39
Searching for a Music File.....	40
Repeat Play	40
Shuffle Play	40

SiriusXM Satellite Radio Operation (Optional)

Receiving Channels with the SiriusXM Tuner.....	41
Tuning Channels by Category	41
Changing the Display	42
Checking the SiriusXM Radio ID Number.....	42
Storing Channel Presets.....	42
Tuning Channels using Presets	42
Search Function	42
Selecting the Channel Directly.....	42
Parental Lock Function.....	43

HDMI Device (Optional)

HDMI Operation.....	44
Setting the Brightness and Contrast	44

Bluetooth Operation

Setup Before Using	45
About Bluetooth.....	45
About the Hands-free Phone.....	45
Before Using Bluetooth.....	45

Hands-free Phone Control

Answering a Call	46
Hanging up the Telephone.....	46
Calling.....	46
Making a phone call using the Phone Menu	46
Using Voice Recognition function.....	47

Using Siri.....	47
Voice Dial Function.....	47
Phone Operation Screen	48
Adjusting the Speech Volume.....	48
Changing the Voice Output.....	48
Muting the Microphone	48
DTMF (Touch-Tone) Function	48
Phone Book Function	48
Searching in the Phone Book	48
Synchronizing the Phone Book.....	48
Deleting the Phone Book Entries.....	49
Setting contacts as Favorites (Shortcut Dialing)	49

Bluetooth Audio

Playback.....	50
Repeat Play.....	50
Shuffle Play.....	50
Connecting a Bluetooth Device.....	50
Disconnecting the Bluetooth Connection.....	50
Switching the connecting Bluetooth Device.....	50

Auxiliary Device (Optional)

Operating Auxiliary Devices (Optional)	51
Setting the Brightness and Contrast.....	51

Camera Operation (Optional)

Rear Camera Operation.....	52
Displaying the Camera Image from the HOME screen	52
Displaying the rear view video while the car is in reverse.....	52
About the Rear Camera Guide.....	52
Front Camera Operation.....	54
Displaying the Camera Image from the HOME screen	54

iDataLink Operation

Access to iDataLink Mode	55
About Parking Sensor screen.....	56
Factory Media Operation.....	56
Factory SiriusXM Operation.....	57

Information

Product Software Update.....	57
About the Supported Formats	57
About MP3/WMA/AAC/FLAC/WAV	57
In Case of Difficulty.....	59
If this Message Appears	60

Specifications.....	61
---------------------	----

Installation and Connections

WARNING	63
CAUTION	63
Precautions	63
Accessory List	64
Installation.....	64
Caution concerning the installation location.....	64
Mounting the Microphone.....	64
Installation example using the Original Mounting Bracket.....	64
Connections.....	65
If an ACC power supply is not available.....	68
System Example.....	69

LIMITED WARRANTY

Operating Instructions

PRECAUTIONS

IMPORTANT INFORMATION

FCC COMPLIANCE STATEMENT

This equipment has been tested and found to comply with the limits for a Class B digital device, pursuant to part 15 of the FCC Rules. These limits are designed to provide more reasonable protection against harmful interference in a residential installation, and are more stringent than "outdoor" requirements.

Operation is subjected to the following two conditions: (1) This device may not cause harmful interference, and (2) this device must accept any interference received, including interference that may cause undesired operation.

This equipment generates, uses, and can radiate radio frequency energy and, if not installed and used in accordance with the instructions, may cause harmful interference to radio communications. However, there is no guarantee that interference will not occur in a particular installation. If this equipment does cause harmful interference to radio or television reception, which can be determined by turning the equipment off and on, you are encouraged to try to correct the interference by one of the following measures:

- Reorient or relocate the receiving antenna.
- Increase the separation between the equipment and the receiver.
- Connect the equipment into an outlet on a circuit different from that to which the receiver is connected.
- Consult an experienced radio/TV technician.

WARNING

Points to Observe for Safe Usage

- Read this manual carefully before using this system components. They contain instructions on how to use this product in a safe and effective manner. Alpine cannot be responsible for problems resulting from failure to observe the instructions in this manual.
- This manual uses various pictorial displays to show you how to use this product safely and to alert you to potential dangers resulting from improper connections and operation. Following are the meanings of these pictorial displays. It is important to fully understand the meanings of these pictorial displays in order to use this manual and the system properly.

- This product may be used with software applications. Please follow all usage instructions and warnings when using this product at all times. Do not use this product or any software application in a manner which will hinder safe operation of your vehicle.

WARNING

- Operation of the system while driving is dangerous. Users should stop vehicle before operating the software.
- Road conditions and regulations take precedence over information contained on the map display: observe actual traffic restrictions and circumstances while driving.
- This software is designed for use exclusively in the unit. It cannot and may not be used in conjunction with other hardware.

WARNING

This symbol means important instructions. Failure to heed them can result in serious injury or death.

INSTALL THE PRODUCT CORRECTLY SO THAT THE DRIVER CANNOT WATCH TV/VIDEO UNLESS THE VEHICLE IS STOPPED AND THE EMERGENCY BRAKE IS APPLIED.

It is dangerous for the driver to watch TV/Video while driving a vehicle. Installing this product incorrectly enables the driver to watch TV/Video while driving. This may cause a distraction, preventing the driver from looking ahead, thus causing an accident. The driver or other people could be severely injured.

DO NOT WATCH VIDEO WHILE DRIVING.

Watching the video may distract the driver from looking ahead of the vehicle and cause an accident.

DO NOT OPERATE ANY FUNCTION THAT TAKES YOUR ATTENTION AWAY FROM SAFELY DRIVING YOUR VEHICLE.

Any function that requires your prolonged attention should only be performed after coming to a complete stop. Always stop the vehicle in a safe location before performing these functions. Failure to do so may result in an accident.

KEEP THE VOLUME AT A LEVEL WHERE YOU CAN STILL HEAR OUTSIDE NOISES WHILE DRIVING.

Excessive volume levels that obscure sounds such as emergency vehicle sirens or road warning signals (train crossings, etc.) can be dangerous and may result in an accident. LISTENING AT LOUD VOLUME LEVELS IN A CAR MAY ALSO CAUSE HEARING DAMAGE.

MINIMIZE DISPLAY VIEWING WHILE DRIVING.

Viewing the display may distract the driver from looking ahead of the vehicle and cause an accident.

DO NOT DISASSEMBLE OR ALTER.

Doing so may result in an accident, fire or electric shock.

USE ONLY IN CARS WITH A 12 VOLT NEGATIVE GROUND.

(Check with your dealer if you are not sure.) Failure to do so may result in fire, etc.

KEEP SMALL OBJECTS SUCH AS SCREWS OUT OF THE REACH OF CHILDREN.

Swallowing them may result in serious injury. If swallowed, consult a physician immediately.

USE THE CORRECT AMPERE RATING WHEN REPLACING FUSES.

Failure to do so may result in fire or electric shock.

DO NOT BLOCK VENTS OR RADIATOR PANELS.

Doing so may cause heat to build up inside and may result in fire.

USE THIS PRODUCT FOR MOBILE 12V APPLICATIONS.

Use for other than its designed application may result in fire, electric shock or other injury.

MAKE THE CORRECT CONNECTIONS.

Failure to make the proper connections may result in fire or product damage.

BEFORE WIRING, DISCONNECT THE CABLE FROM THE NEGATIVE BATTERY TERMINAL.

Failure to do so may result in electric shock or injury due to electrical shorts.

DO NOT ALLOW CABLES TO BECOME ENTANGLED IN SURROUNDING OBJECTS.

Arrange wiring and cables in compliance with the manual to prevent obstructions when driving. Cables or wiring that obstruct or hang up on places such as the steering wheel, gear lever, brake pedals, etc. can be extremely hazardous.

DO NOT SPLICE INTO ELECTRICAL CABLES.

Never cut away cable insulation to supply power to other equipment. Doing so will exceed the current carrying capacity of the wire and result in fire or electric shock.

DO NOT DAMAGE PIPE OR WIRING WHEN DRILLING HOLES.

When drilling holes in the chassis for installation, take precautions so as not to contact, damage or obstruct pipes, fuel lines, tanks or electrical wiring. Failure to take such precautions may result in fire.

DO NOT USE BOLTS OR NUTS IN THE BRAKE OR STEERING SYSTEMS TO MAKE GROUND CONNECTIONS.

Bolts or nuts used for the brake or steering systems (or any other safety-related system), or tanks should NEVER be used for installations or ground connections. Using such parts could disable control of the vehicle and cause fire etc.

DO NOT INSTALL IN LOCATIONS WHICH MIGHT HINDER VEHICLE OPERATION, SUCH AS THE STEERING WHEEL OR GEARSHIFT.

Doing so may obstruct forward vision or hamper movement etc. and results in serious accident.

 CAUTION

This symbol means important instructions. Failure to heed them can result in injury or material property damage.

HALT USE IMMEDIATELY IF A PROBLEM APPEARS.

Failure to do so may cause personal injury or damage to the product. Return it to your authorized Alpine dealer or the nearest Alpine Service Center for repairing.

HAVE THE WIRING AND INSTALLATION DONE BY EXPERTS.

The wiring and installation of this unit requires special technical skill and experience. To ensure safety, always contact the dealer where you purchased this product to have the work done.

USE SPECIFIED ACCESSORY PARTS AND INSTALL THEM SECURELY.

Be sure to use only the specified accessory parts. Use of other than designated parts may damage this unit internally or may not securely install the unit in place. This may cause parts to become loose resulting in hazards or product failure.

ARRANGE THE WIRING SO IT IS NOT CRIMPED OR PINCHED BY A SHARP METAL EDGE.

Route the cables and wiring away from moving parts (like the seat rails) or sharp or pointed edges. This will prevent crimping and damage to the wiring. If wiring passes through a hole in metal, use a rubber grommet to prevent the wire's insulation from being cut by the metal edge of the hole.

DO NOT INSTALL IN LOCATIONS WITH HIGH MOISTURE OR DUST.

Avoid installing the unit in locations with high incidence of moisture or dust. Moisture or dust that penetrates into this unit may result in product failure.

 **NOTICE**

Product Cleaning

Use a soft dry cloth for periodic cleaning of the product. For more severe stains, please dampen the cloth with water only. Anything else has the chance of dissolving the paint or damaging the plastic.

Temperature

Be sure the temperature inside the vehicle is between +45°C (+113°F) and 0°C (+32°F) before turning your unit on.

Maintenance

If you have problems, do not attempt to repair the unit yourself. Return it to your Alpine dealer or the nearest Alpine Service Station for servicing.

Protecting the USB connector

- Only an iPhone or USB flash drive can be connected to the USB connector on this unit. Correct performance using other USB products cannot be guaranteed.
- If the USB connector is used, be sure to use only the supplied connector cable with the unit. A USB hub is not supported.
- Depending on the connected USB flash drive, the unit may not function or some functions may not be performed.
- The audio file format that can be played back on the unit is MP3/WMA/AAC/FLAC/WAV.
- Artist/song name, etc., can be displayed. Certain, special characters may not be correctly displayed.

 **CAUTION**

Alpine accepts no responsibility for lost data, etc., even if data, etc., is lost while using this product.

On Handling USB Flash drive

- This unit can control a memory storage device that supports the USB Mass Storage Class (MSC) protocol. Playable audio file formats are MP3, WMA, AAC, FLAC and WAV.
- USB Flash drive function is not guaranteed. Use USB flash drive according to the terms of agreement. Read the USB flash drive Owner's Manual thoroughly.
- Avoid usage or storage in the following locations: Anywhere in the car exposed to direct sunlight or high temperatures.
Anywhere the possibility of high humidity or corrosive substances are present.
- Fix the USB flash drive in a location where driver operation will not be hindered.
- USB Flash drive may not function correctly at high or low temperature.
- Use only certified USB flash drive. Note that even certified USB flash drive, may not function correctly depending on its type or state.
- Depending on the settings of the USB flash drive type, memory state or encoding software, the unit may not play back or display properly.
- USB Flash drive may take time to start playback. If there is a particular file other than audio in the USB flash drive, it may take considerable time before the file is played back or searched.
- The unit can play back "mp3," "wma" or "m4a" file extensions.
- Do not add the above extensions to a file other than audio data. This non-audio data will not be recognized. The resulting playback may contain noise that can damage speakers and/or amplifiers.
- It is recommended to back up important data on a personal computer.
- Do not remove the USB device while playback is in progress. Change SOURCE to something other than USB, then remove the USB device to prevent possible damage to its memory.





- Windows Media are trademarks, or registered trademarks of Microsoft Corporation in the United States and/or other countries.
- Apple, iPhone and Siri are trademarks of Apple Inc., registered in the U.S. and other countries. Apple CarPlay is a trademark of Apple Inc.
- Use of the Made for Apple and Works with Apple badges means that an accessory has been designed to connect specifically to the Apple product(s) identified in the Made for Apple badge and to work specifically with the technology identified in the Works with Apple badge, and has been certified by the developer to meet Apple performance standards. Apple is not responsible for the operation of this device or its compliance with safety and regulatory standards.
- Please note that the use of this accessory with an Apple product may affect wireless performance.
- Use of the Apple CarPlay logo means that a vehicle user interface meets Apple performance standards. Apple is not responsible for the operation of this vehicle or its compliance with safety and regulatory standards. Please note that the use of this product with iPhone may affect wireless performance.
- Sirius, XM and all related marks and logos are trademarks of Sirius XM Radio Inc. All rights reserved.
- HD Radio Technology manufactured under license from iBiquity Digital Corporation. U.S. and Foreign Patents. For patents see <http://dts.com/patents>. HD Radio and the HD, HD Radio, and "ARC" logos are registered trademarks or trademarks of iBiquity Digital Corporation in the United States and/or other countries.
- Google, Android, Google Play and Android Auto are trademarks of Google LLC.
To use Android Auto on your car display, you'll need an Android Auto compatible vehicle or aftermarket stereo, an Android phone running Android 6.0 or higher, and the Android Auto app.
- The terms HDMI and HDMI High-Definition Multimedia Interface, and the HDMI Logo are trademarks or registered trademarks of HDMI Licensing LLC in the United States and other countries.
- The Bluetooth® word mark and logos are registered trademarks owned by the Bluetooth SIG, Inc. and any use of such marks by ALPS ALPINE Co., LTD. is under license. Other trademarks and trade names are those of their respective owners.
- MPEG Layer-3 audio coding technology licensed from Fraunhofer IIS and Thomson. Supply of this product only conveys a license for private, non-commercial use and does not convey a license nor imply any right to use this product in any commercial (i.e. revenue-generation) real time broadcasting (terrestrial, satellite, cable and/or any other media), broadcasting/streaming via internet, intranets and/or other networks or in other electronic content distribution systems, such as pay-audio or audio-on-demand applications. An independent license for such use is required. For details, please visit <http://www.mp3licensing.com>

Made for iPhone X, iPhone 8, iPhone 8 Plus, iPhone 7, iPhone 7 Plus, iPhone SE, iPhone 6s, iPhone 6s Plus, iPhone 6, iPhone 6 Plus, iPhone 5s

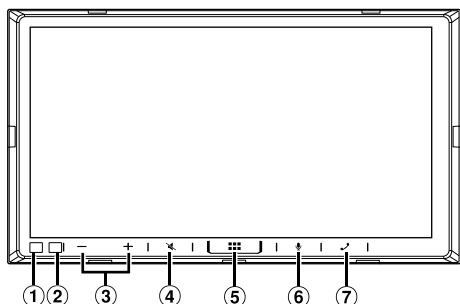
Getting Started

Location of Controls



- 1 Dimmer Sensor**
Senses the brightness of the car interior.
- 2 Remote Sensor**
Point the remote control transmitter towards the remote sensor within a range of 2 meters.
- 3 - / + (DOWN/UP) button**
Adjusts the volume.
- 4  (MUTE) button**
Activates/deactivates MUTE mode.
- 5  button**
Activate Siri function or voice recognition mode.
- 6  (HOME) button**
Displays the HOME screen.
- 7  (Phone) button**
Displays the Phone Menu screen.
Touch to start a conversation when a call is incoming.

About the button descriptions used in this Owner's Manual

The buttons found on the face of the unit are expressed in bold (e.g.  (HOME)). The buttons found on the touch-screen display are shown in bold within brackets, [] (e.g. [OK]).

Turning Power On or Off

When the ignition key is turned to ACC or ON, the opening screen will be automatically displayed.

1 Turn the ignition key to the ACC or ON position.

The unit turns on.

- When the unit is used for the first time, the Radio main screen is displayed.
- When turned on, the unit displays the last screen that was displayed before the ignition key was turned off. For example, if the unit is in radio mode when ignition is turned off, it will remain in radio mode when ignition is turned back on.

2 To turn the unit to off, turn the ignition key to the OFF position.

- *The unit is a precision device. Careful handling of the unit should provide you with years of trouble-free operation.*
- *Some of this unit's functions cannot be performed while the vehicle is in motion. Be sure to stop your vehicle in a safe location and apply the parking brake before attempting these operations.*

Adjusting the Volume

Adjust the volume by touching - / +.

Volume decreases/increases continuously by touching and holding - / +.

Volume: 0 to 35

Lowering Volume Quickly

Audio Mute function instantly lowers the volume level to 0.

1 Touch the (MUTE) button to activate MUTE mode.

The audio level will be 0.

2 Touch the (MUTE) button again to bring the audio back to previous volume level.

Touch Screen Operation

You can operate the unit by using the touch panel display.

- Be sure to touch the onscreen button lightly with the pad of your finger to avoid scratching the display.

Touch operation

Touch a button or list item on the screen lightly.



- If you touch a button and there is no reaction, remove your finger.
- Onscreen buttons that cannot be operated are dimmed.

Swipe operation

Move your finger lightly with a swipe.

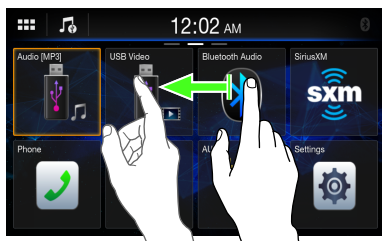

Drag & Drop operation

Touch and hold the desired item, then drag it to its new location by moving your finger, then release your finger to place the item.



- Except for USB Photo mode, it is not possible to narrow the screen with two fingers (pinch in) or spread the screen (pinch out).

Switching Sources

1 Touch the (HOME) button.

The HOME screen is displayed.



2 Touch a widget of your desired source.

- In the HOME screen, you can change the widget location on the screen. For details, see "About the HOME Screen" (page 12).

Selecting an Item in a List

To scroll through a list, perform the following operations.

Touch the screen and slide your finger up and down.

The screen will scroll along with your finger movement.

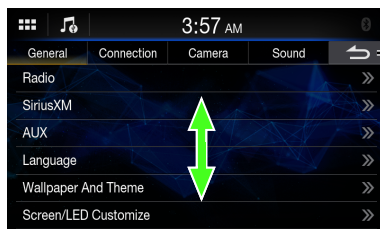

Returns to the previous screen. Depending on the function, this button may cancel the operations performed on the screen.

- After touching the screen, move your finger away from the screen before dragging and that item will be selected.

About the HOME Screen

In the HOME screen, select a widget to perform various settings and operations of the function.

Touch the (HOME) button.

The HOME screen is displayed.

- You can also display the HOME screen by touching [] at the top of the screen.

■ HOME screen example

HOME screen navigation

Swipe the HOME screen horizontally with your finger to change the page. Up to 3 pages exist.

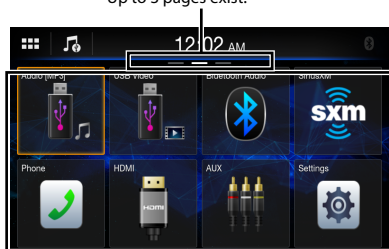

Widget

Touch to activate the function.

- After selecting [Audio] widget, it is possible to switch the mode to USB Audio mode, iPod mode for iPhone or Bluetooth Audio mode.

Editing HOME screen

You cannot operate the Widgets editing screen while driving.

Your vehicle must be parked with the ignition key in the ACC or ON position. For details, see "To display the Setup Menu screen" in "Setup Operation" (page 13).

In the Widgets editing screen, you can change the audio source order or set the display/hide settings.

1 Touch and hold the HOME screen for at least a second.

The widgets editing screen is displayed.



Additional candidate widgets

- The source icon displayed in the Widgets editing screen is displayed only when usable setup and conditions of each Audio source are fulfilled. For details on setup and conditions of each audio source, see "Switching Sources" (page 11).

■ Adding a widget

Drag and drop a widget from the additional candidate widgets area to the desired position of the HOME screen image area.

- To show more candidate widgets, swipe horizontally.
- There are 3 sizes of widgets.

■ Changing the order of widget

Drag and drop the widget to the desired location.

■ Deleting a widget from the HOME screen

Drag and drop a widget from the HOME screen image area to .

-  is displayed while touching a widget.

2 Touch the (HOME) button.

The HOME screen is displayed.

About the Indicator Display

The Indicator Bar at the top of the screen displays various types of information, like the current time.



- 1 Recalls the HOME screen.
- 2 Displays the currently playing audio source. Touch to return to the Audio source screen.
- 3 Indicates the current time. You can switch between the 12 hour display and 24 hour display options (page 18).
- 4 Displays the SiriusXM signal strength when connecting to SiriusXM Tuner. (If SiriusXM Tuner is not connected, it is not displayed.)
- 5 Lights up when connected to a Bluetooth compatible device. (Does not display when connection is set to OFF.)

Setup

Setup Operation

To display the Setup Menu screen:

Your vehicle must be parked with the ignition key in the ACC or ON position. To do this, follow the procedures below.

- 1 Bring your vehicle to a complete stop at a safe location. Engage the parking brake.
- 2 Release the parking brake. (For safety, release the parking brake while depressing the foot brake pedal).
- 3 Engage the parking brake again.

- For automatic transmission vehicles, place the transmission lever in the Park position.

Now, the locking system for the Setup operation has been released. Engaging the parking brake can reactivate the Setup Menu, as long as the car's ignition has not been turned off. It is not necessary to repeat the above procedure (1 through 3).

Each time the ignition is turned OFF, perform the above procedure.

1 Touch the (HOME) button.

The HOME screen is displayed.



[Settings] button

2 Touch [Settings].

The Settings menu screen is displayed.

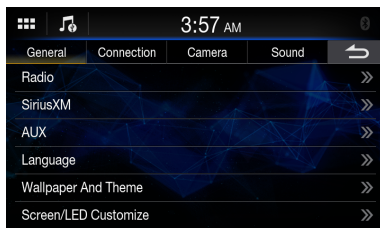

3 Touch the required setting genre on the upper part of the Settings menu screen, and then touch the setting item.

Setting genres:

General: See "General Setup" (page 14).

Connection: See "Connection (Bluetooth) Setup" (page 20).

Camera: See "Camera Setup" (page 21).

Sound: See "Sound Setup" (page 24).

General Setup

[General] is selected on the Settings menu screen.

■ General Setup Menu screen

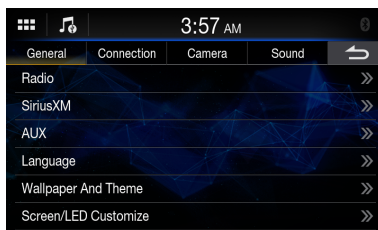

Setting items:

Radio (page 14)

SiriusXM (page 15)

AUX (page 16)

Language (page 16)

Wallpaper And Theme (page 17)

Screen/LED Customize (page 17)

Date/Clock (page 18)

Display Off (page 18)

About (page 18)

Installation (page 19)

Steering Wheel Position (page 19)

Mute While Backing Up (page 17)

iDatalink (page 19)

Radio Setup

[Radio] is selected on the General Setup Menu screen.

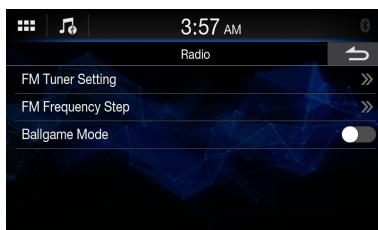

Setting the TUNER (FM) Tone Quality (Tuner Condition)

This unit can set your preferred tone quality for FM radio source.

Setting item:

FM Tuner Setting

Setting contents:

Normal (Initial setting) / HiFi / Stable

Normal:	Standard setting
HiFi:	High-quality setting
Stable:	Control noise

- Noise may be more noticeable when [HiFi] is set, depending on the reception status. In this case, the [Normal] setting is recommended.

Setting the TUNER (FM) Frequency Step

During manual tuning, you can select the frequency step for FM analog radio station searching.

Setting item:

FM Frequency Step

Setting contents:

100 kHz / 200 kHz (Initial setting)

Setting the Ballgame Mode

To receive live broadcast with HD Radio, set [Ballgame Mode] to [On].

Setting item:

Ballgame Mode

Touch [] (Off) or [] (On) of "Ballgame Mode".

SiriusXM Setup

[Sirius XM] is selected on the General Setup Menu screen.

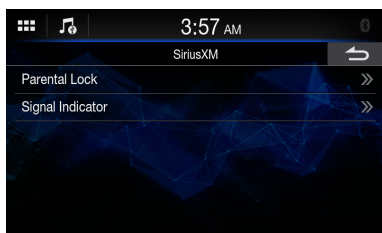

Setting the Parental Lock

You can lock out channels with passcode protection. Channels that are locked cannot be accessed without entering the passcode. You can unlock a channel or change the passcode using this menu option.

Setting item:

Parental Lock

1 Touch [Parental Lock].

A passcode input screen is displayed.

2 Touch the numeric keypad to input a 4-digit passcode.

The initial default 4-digit passcode is set to 0000.

After entering the digit, it is displayed as "●".

- Touch [] to delete an entered number.

3 Touch [OK].

Setting the Lock status of individual channels

4 Touch [Locked Channels].

The channels list screen is displayed.

5 Touch [] (Off) or [] (On) of the channels list to set the Parent Lock.

Clearing the Lock of ALL the locked Channels

4 Touch [Clear All Locked Channels].

5 Touch [Yes] to clear the lock of all the locked channels.

Touch [No] to cancel.

Changing the Lock Passcode

4 Touch [Edit Code].

The numeric keypad screen is displayed.

5 Use the keypad to enter the current (old) 4-digit passcode, and then touch [OK].

The initial passcode is set to "0000".

- Touch [] to delete an entered number.

6 Touch [OK] to confirm the entry.

7 Now use the keypad to enter the new 4-digit passcode.

8 Touch [OK].

9 Use the keypad to enter the new 4-digit passcode a second time to verify it, and then touch [OK].

- Remember to keep a note of the passcode in a safe place in case you forget the code.

Signal Strength Information

While listening to a SiriusXM Channel, the Signal strength of the current channel will be displayed.

Setting item:

Signal Indicator

This menu item displays the SiriusXM signal strength as Excellent, Good, Weak or No Signal.

- If the Signal indicator reports Weak or No Signal and your vehicle is parked outside with no obstructions to the southern sky, then your SiriusXM antenna may not be properly installed or may have become damaged.

AUX Setup

[AUX] is selected on the General Setup Menu screen.

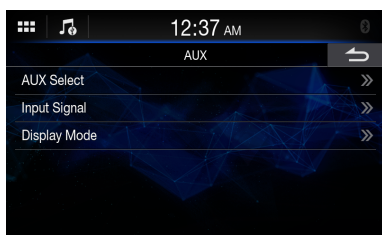

■ Usable 4-pole mini AV plug

The unit accepts the following 4-pole mini AV plug pin-out:

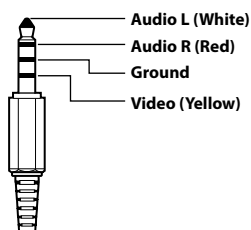

- Please check pin-out carefully before use of this product. Depending on the cable, there may be no picture and/or sound.

Setting the AUX Select

You can set up the connected AUX device.

Setting item:

AUX Select

Setting contents:

AUX (Initial setting) / Factory Media + Drive Recorder

- When "AUX" is set, audio will not be output from Factory Media or Factory SiriusXM mode.
- When "Factory Media + Drive Recorder" is set, AUX In Audio will be used by the Factory Media and Factory SiriusXM mode. Only AUX In Video will be output in the AUX mode. Audio will not be output.

Setting the Input Signal

The video input signal type can be chosen.

Setting item:

Input Signal

Setting contents:

NTSC (Initial setting) / PAL

Setting the Display Mode

You can switch the Display Mode of the video file to be played.

Setting item:

Display Mode

Setting contents:

Full (Initial setting) / 4.3

Language Setup

[Language] is selected on the General Setup Menu screen.

The Setup menu, feedback information, etc. for this unit can be changed to appear in the selected language.

Setting item:

Language

Setting contents:

English (Initial setting) / Deutsch / Français / Español / Italiano / Português / Polski / Nederlands / Dansk / Suomi / Norsk / Svenska / Slovenčina / Čeština / Magyar / Ελληνικά / Türkçe / русский / תּוֹרְבֵּעַ / العربية / Bahasa Indonesia / Bahasa Melayu / Tiếng Việt / 中文 / 日本語

- The currently selected language is displayed.

Wallpaper Setup

[**Wallpaper And Theme**] is selected on the General Setup Menu screen.

You can change the wallpaper of the display screen from 4 different colored default images or your image.

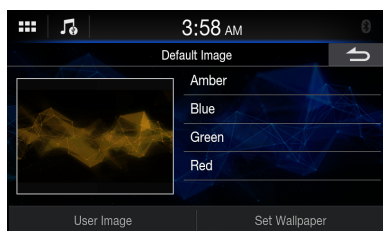

Setting a Wallpaper using a default image

Setting contents:

Amber / Blue / Green / Red

Touch the desired image, and then touch [Set Wallpaper].

Setting a Wallpaper using your image

1 Touch [User Image].

The image selecting screen is displayed.

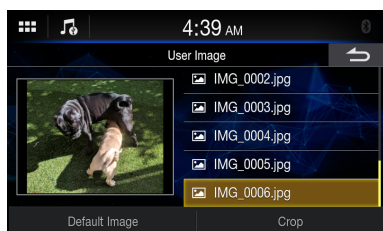

2 Select an image stored on the connected USB Flash drive.

The selected image thumbnail is displayed.

If not using an image as a wallpaper, touch [**Default Image**] to return to the previous screen without selecting.

3 Touch [Crop].

4 Touch the area to be trimmed for a wallpaper.

If the image is 800 × 480 pixel, this step is not necessary.

5 Touch [Set Theme] to change the theme color.

6 Touch the desired color.

7 Touch [Set Wallpaper].

Screen/LED Customize Setup

[**Screen/LED Customize**] is selected on the General Setup Menu screen.

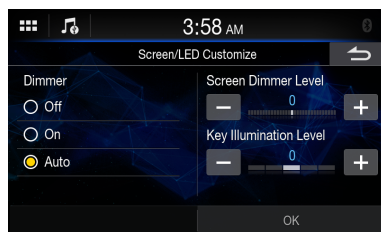

Setting item:

Dimmer / Screen Dimmer Level / Key Illumination Level

Setting the Brightness of the Backlighting (Dimmer)

Backlighting is provided by LEDs light built into the liquid crystal panel. The illumination control adjusts the brightness of the backlighting based on the car ambient lighting for easier viewing.

Setting item:

Dimmer

Setting contents:

Off / On / Auto (Initial setting)

Off: Deactivate Auto Dimmer mode to keep the background illumination of the monitor bright.

On: Keep the background illumination of the monitor dark.

Auto: Adjust the brightness of the background illumination of the monitor automatically to the brightness of the car interior.

- When [**On**] is set, the setting is also applied for the button lighting in "Adjusting the Dimmer of Button Lighting at Night" (page 17) and "Adjusting the Minimum Level of Backlight" (page 18).

Adjusting the Minimum Level of Backlight

You can adjust the brightness of the backlight. This function could be used, for instance, to change the screen brightness while traveling at night.

Setting item:

Screen Dimmer Level

Setting contents:

-15 to 15 (Initial setting: 0)

- This setting is only available when "Dimmer" is set to [**On**] or [**Auto**].

Adjusting the Dimmer of Button Lighting at Night

You can adjust the brightness of the button lighting at night with the dimmer.

Setting item:

Key Illumination Level

Setting level:

-2 to 2 (Initial setting: 0)

- This setting is only available when “Dimmer” is set to [On] or [Auto].

Date/Clock Setup

[Date/Clock] is selected on the General Setup Menu screen. You can set the display type of the Date/Clock adjustment and the clock display to 12-hours or 24-hours, depending on your preference.

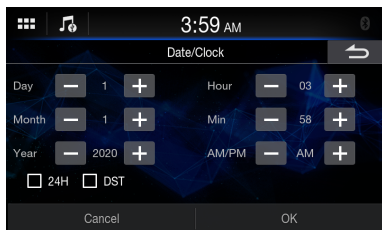

Setting item:

Date/Clock

Touch [+] or [-] to adjust the day, month, year, hour, minute and AM/PM.

- To change to 24-hour, set “24H” to [On] (☑).
- To set the daylight saving time (Summer Time mode), set “DST” to [On] (☑).

Display Off Setting

When [Display Off] is selected on the General Setup Menu screen, the display is turned Off.

Setting item:

Display Off

- To cancel Display Off mode, touch the screen or any button.
- Display Off mode is canceled when the power or ACC is turned off.
- When the gear lever is shifted to the reverse (R) position and the rear camera is connected, the rear camera image is displayed.
- When a call is received on a Bluetooth-connected phone, the incoming call screen is displayed.
- You can also activate Display Off mode directly by touching the [Display Off] widget on the HOME screen.

About iLX-407

[About] is selected on the General Setup Menu screen. [About] enables you to check the Serial No., Firmware Version, Model Name, and to initialize various settings.

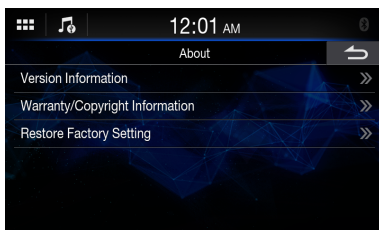

Displaying the Product Information

You can view the version information of this product. Make note of this information and refer to it whenever you contact Alpine Tech Support or an Alpine-authorized dealer.

Setting item:

Version Information

Setting contents:

Serial No. / SYSTEM version / Firmware Version

Displaying Warranty/Copyright Information

Setting item:

Warranty/Copyright Information

Setting contents:

Open source licenses / Notice

Initializing the System

You can initialize all data, to restore the factory settings. Remove the USB flash drive, etc. from the system before operation.

1 Touch [Restore Factory Setting].

2 After the confirmation message appears, touch [Yes].

The confirmation screen appears.

3 Touch [Confirm].

The system starts initialization.

- Do not turn on/off the power, change the ignition key position or remove the screen panel until system restart is completed.

Installation Setup

[**Installation**] is selected on the General Setup Menu screen.

Vehicle Setup enables you to check the connection status of Reverse Lead/Parking Brake Lead.

When selecting the item, the Installation check screen is displayed.

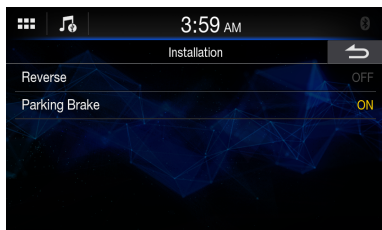

Setting item:

Installation

Setting contents:

Reverse / Parking Brake

Steering Wheel Position Setting

[**Steering Wheel Position**] is selected on the General Setup Menu screen.

Set this item when Apple CarPlay is used/Android smartphone which installed Android Auto App is connected.

This setting influences Apple CarPlay/Android Auto mode.

Setting item:

Steering Wheel Position

Setting contents:

Left (Initial setting) / Right

Mute Setting

[**Mute While Backing Up**] is selected on the General Setup Menu screen.

You can set the sound will be muted automatically when the gear lever is moved to the reverse (R) position.

Setting item:

Mute While Backing Up

Touch [] (Off) or [] (On) of "Mute While Backing Up".

iDataLink Setting

[**iDataLink**] is selected on the General Setup Menu screen.



Setting the Default Vehicle Screen

You can set the Default Vehicle Screen displayed in iDataLink mode.

Setting item:

Default Vehicle Screen

Setting contents:

Gauges / Climate / Parking Assist / Vehicle Info. / Last Mode (Initial setting)

- Depending on the car, some setting contents or this setting item may not be displayed.

Setting the Parking Assist Enable

You can set up the camera for Parking Assist.

Setting item:

Parking Assist Enable

Setting contents:

Off (Initial setting) / Primary Camera / Secondary Camera

Setting the Maestro Module

You can change the setting of the connected iDataLink module.

Setting item:

Maestro Module

- This setting is only available when the iDataLink Maestro® module (sold separately) is connected.
- Depending on the iDataLink module, the setting contents may differ.

Connection (Bluetooth) Setup

[**Connection**] is selected on the Setup menu screen.

■ Connection Setup Menu screen

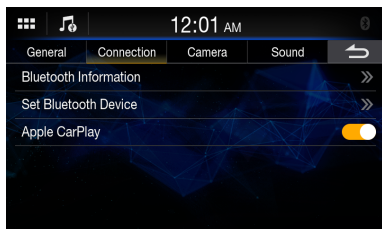

Setting items:

- Bluetooth Information (page 20)
- Set Bluetooth Device (page 20)
- Apple CarPlay (page 21)

Displaying Bluetooth Information

[**Bluetooth Information**] is selected on the Connection Setup Menu screen.

You can display the Bluetooth device name and device address of this unit.

Setting item:

- Bluetooth Information

Pairing the Bluetooth Device

[**Set Bluetooth Device**] is selected on the Connection Setup Menu screen.

Search for Bluetooth compatible devices.

Setting item:

- Set Bluetooth Device

1 Touch [Set Bluetooth Device].

The Bluetooth Setup screen is displayed.

- You can also display the Bluetooth Setup screen directly by touching the [**Bluetooth Settings**] widget on the HOME screen.

2 Select this unit on the Bluetooth device.

A message about the device to be registered is displayed.

3 Touch [Yes].

The Bluetooth device is connected.

If you connecting to a smartphone, a message to download the phonebook is displayed.

4 Touch [🎵] (Audio) or/and [📞] (Hands-free) of the device you want to connect from the list.

Audio: Device is used as an Audio device.
Hands-free: Device is used as a Hands Free Device.

- You can register up to 5 Bluetooth compatible mobile phones.
- You can connect 1 Bluetooth Device to each of Bluetooth Audio mode and Hands-free mode.
- The Bluetooth registration process differs depending on the device version and SSP (Simple Secure Pairing). If a 4 or 6 character Passcode appears on this system, enter the Passcode on the Bluetooth device.
- If a 6 character Passkey appears on this device, make sure the same passkey is displayed on the Bluetooth compatible device and touch [OK].
- If all 5 devices have been registered, you cannot register a 6th device. To register another device, you need to delete one of the other 5 devices first.

Setting the Bluetooth Device

Select one of 5 paired Bluetooth compatible devices that you previously registered.

Touch [🎵] (Audio) or [📞] (Hands-free) of the device you want to connect from the Paired Device list.

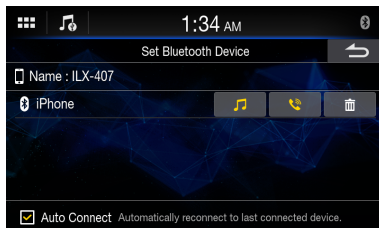

- You can also change the connected device by touching the device name.

Deleting a Bluetooth Device from the list

You can delete the information of a previously connected Bluetooth compatible device.

1 Touch [🗑️] of the Bluetooth compatible device to delete from the Paired Device list.

2 Touch [Yes].

- Touching [No] will cancel the setting.

Setting the Auto Connection

You can connect the last connected device automatically.

Set "Auto Connect" to [On] (☑).

Apple CarPlay Setup

[**Apple CarPlay**] is selected on the Connection Setup Menu screen.

To use the Apple CarPlay (page 31), set "Apple CarPlay" to [On].

Setting item:

Apple CarPlay

Touch [] (Off) or [] (On) of "Apple CarPlay".

Camera Setup

[**Camera**] is selected on the Setup Menu screen.

You can set up items related to the Camera.

■ Camera Setup Menu screen

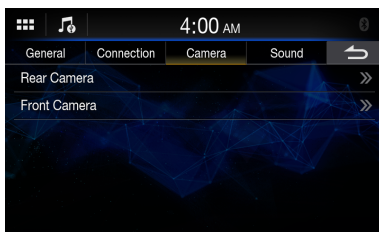

Setting items:

Rear Camera (page 21)

Front Camera (page 23)

Rear Camera Setup

[**Rear Camera**] is selected on the Camera Setup Menu screen.



Camera Input Setting

[**Camera Select**] is selected on the Camera Setup Menu screen.

Setting item:

Camera Select

Setting contents:

Off (Initial setting) / Rear

Off: No camera is connected.

Rear: Rear camera is connected.

Camera Signal Input Setting

[**Camera Signal**] is selected on the Camera Setup Menu screen.

When the camera is connected, the video input signal type can be chosen.

Further setting item:

Camera Signal

Setting contents:

NTSC (Initial setting)/PAL

Rear Camera Guide Settings

[Parking Guide Adjust] is selected on the Camera Setup Menu screen.

You can adjust the camera guide position.

Setting item:

Parking Guide Adjust

1 Touch [Parking Guide Adjust] on the Camera Setup menu screen.

The camera guide adjustment screen is displayed.

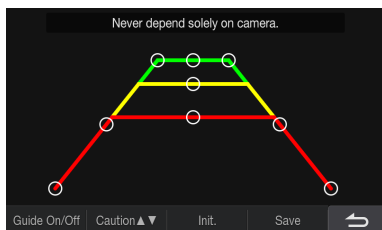

2 Slide [○] to adjust.

3 After the adjustment is completed, touch [Save].

- Touching [Init.] clears adjustments and returns to the setting before guide line alteration.

4 Touch [↩] to complete the adjustment and return to the previous screen.

Turning the Rear Camera Guide On/Off

When displaying the rear camera view on the screen, you can set to hide or show the camera guide.

Setting item:

Guide On/Off

Setting contents:

Off / On

Adjusting the Caution Position

You can move the position of the displaying message on the screen.

Setting item:

Caution ▲▼

Camera Picture Quality Setup

[Visual Adjust] is selected on the Camera Setup Menu screen.

You can adjust the picture quality for the primary and secondary cameras.

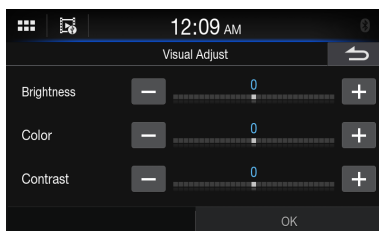

Setting item:

Visual Adjust

Adjusting Brightness

Setting item:

Brightness

Setting contents:

-15 to 15 (Initial setting: 0)

- You can adjust the brightness between MIN (-15) and MAX (+15).

Adjusting Color of Display

Setting item:

Color

Setting contents:

-15 to 15 (Initial setting: 0)

- You can adjust the color between MIN (-15) and MAX (+15).

Adjusting Display Contrast

Setting item:

Contrast

Setting contents:

-15 to 15 (Initial setting: 0)

- You can adjust the contrast between MIN (-15) and MAX (+15).

Camera Interrupt Setting (DISPLAY OFF Mode)

You can set whether to display the rear camera image when the gear lever is moved to the reverse (R) position while the unit is turned off.

Setting item:

Camera Interrupt (DISPLAYOFF Mode)

Touch [○] (Off) or [●] (On) of "Camera Interrupt (DISPLAYOFF Mode)".

Front Camera Setup

[**FrontCamera**] is selected on the Camera Setup Menu screen.

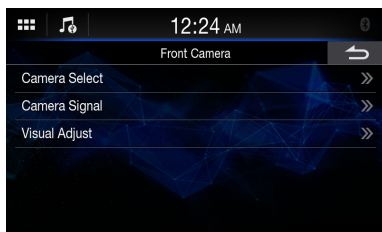

Camera Input Setting

[**Camera Select**] is selected on the Camera Setup Menu screen.

Setting item:

Camera Select

Setting contents:

Off (Initial setting) / Front

Off: No camera is connected.

Front: Front camera is connected.

Camera Signal Input Setting

[**Camera Signal**] is selected on the Camera Setup Menu screen.

When the camera is connected, the video input signal type can be chosen.

Further setting item:

Camera Signal

Setting contents:

NTSC (Initial setting)/PAL

Camera Picture Quality Setup

[**Visual Adjust**] is selected on the Camera Setup Menu screen.

You can adjust the picture quality for the primary and secondary cameras.

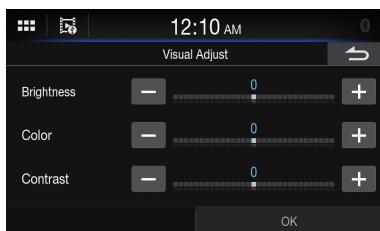

Setting item:

Visual Adjust

Adjusting Brightness

Setting item:

Brightness

Setting contents:

-15 to 15 (Initial setting: 0)

- You can adjust the brightness between MIN (-15) and MAX (+15).

Adjusting Color of Display

Setting item:

Color

Setting contents:

-15 to 15 (Initial setting: 0)

- You can adjust the color between MIN (-15) and MAX (+15).

Adjusting Display Contrast

Setting item:

Contrast

Setting contents:

-15 to 15 (Initial setting: 0)

- You can adjust the contrast between MIN (-15) and MAX (+15).

Sound Setup

[Sound] is selected on the Settings menu screen. You can set up items related to the sound quality.

■ Sound Setup Menu screen

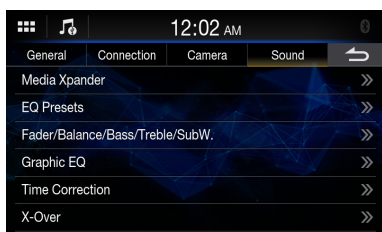

Setting items:

- Media Xpander (page 24)
- EQ Presets (page 24)
- Fader/Balance/Base/Treble/SubW. (page 24)
- Graphic EQ (page 25)
- Time Correction (page 26)
- X-Over (page 26)
- Volume (page 27)
- Subwoofer (page 27)
- Rear Speaker (page 28)
- Defeat (page 28)

Setting the Media Xpander (MX)

[Media Xpander] is selected on the Sound Setup Menu screen.

Media Xpander (MX) makes vocals or instruments sound distinct regardless of the music source. The SiriusXM, USB Flash drive and iPod, will be able to reproduce the music clearly even in cars with a lot of road noise.

Setting item:

Media Xpander

- 1 Touch the check box of [ALL MX].
- 2 Touch any of [Off] [Level 1] [Level 2] [Level 3].

- To cancel MX mode, set [Off] in step 1.
- MP3/WMA/AAC can have its own MX setting.
- When the Defeat setting is [On], you cannot perform the set up.
- The MX setting can be performed only when a source is currently selected.

Equalizer Settings

[EQ Presets] is selected on the Sound Setup Menu screen. 10 typical equalizer settings are preset at the factory for a variety of musical source material.



Setting item:

EQ Presets

Setting contents:

FLAT (Initial setting) / POP / ROCK / CLASSICAL / JAZZ / ELECTRONIC / HIP HOP / EASY LISTENING / COUNTRY / NEWS

- Only one type can be set to On.
- When Equalizer Presets is set, the linked Graphic EQ settings are also changed. We recommend storing Graphic EQ settings in a Preset in advance.
- The Equalizer Presets setting can be configured when Defeat is Off.

Fader/Balance/Bass/Treble/Subwoofer Settings

[Fader/Balance/Bass/Treble/SubW.] is selected on the Sound Setup Menu screen.

Setting item:

Fader/Balance/Bass/Treble/SubW.

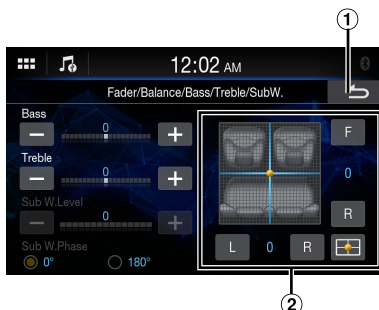

- ① Cancel
Sound setup finishes.
- ② Fader/Balance Image area

Setting the Fader/Balance

Touch the desired point within the image area, or touch [F] (Front), [R] (Rear), [L] (Left) or [R] (Right).

Fader:

15 (F) to 15 (R)

Balance:

15 (L) to 15 (R)

- To reset to the initial setting (F/R: 0, L/R: 0), touch .

Adjusting the Bass/Treble

Touch [+] or [-] for each item to be adjusted.

Setting item:

Bass, Treble

Setting contents:

-10 to 10 (Initial setting: 0)

Setting the Subwoofer

Adjusting the Subwoofer Level

Setting item:

Sub W.Level

Setting contents:

0 (Initial setting) to 15

- This setting is only available when "Subwoofer" is set to [On] (page 27).

Setting the Subwoofer Phase

The subwoofer output phase is toggled Subwoofer Normal (0°) or Subwoofer Reverse (180°).

Setting item:

Sub W.Phase

Setting contents:

0° (Initial setting), 180°

- This setting is only available when "Subwoofer" is set to [On] (page 27).

Graphic Equalizer Curve Settings (Graphic EQ)

[Graphic EQ] is selected on the Sound Setup Menu screen. You can modify the Equalizer settings to create a response curve more appealing to your personal taste.

Setting item:

Graphic EQ

Setting contents:

-7 to 7

- This setting is only available when "Defeat" is set to [On] (page 28).

- 1 Touch [Graphic EQ] on the Sound Setup menu screen.

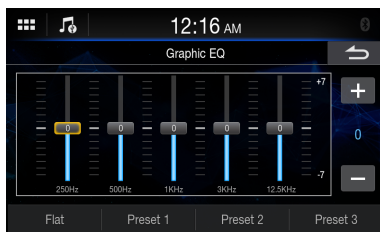

- 2 Touch the band to be adjusted.
- 3 Touch [+] or [-] to adjust the level of the band.
 - You can also adjust the level of the band by moving the slider.
- 4 To adjust another band, repeat step 2 to 3, and adjust all bands.
- 5 To store the adjusted setting value, touch and hold [Preset 1], [Preset 2], or [Preset 3] for at least 2 seconds.

- Settings exceeding the frequency of adjacent bands are not available.
- While adjusting the Graphic EQ, you should consider the frequency response of the connected speakers.
- When the Graphic EQ is adjusted, the Equalizer Presets are overridden.
- When Equalizer Presets is set, the linked Graphic EQ settings are also changed. We recommend storing Graphic EQ settings in a Preset in advance.
- Touch [Flat] to initialize all values.

Calling the Graphic EQ adjusted value

Touch [Preset 1], [Preset 2], or [Preset 3].

The setting stored in the Preset will be recalled.

Time Correction Settings

[**Time Correction**] is selected on the Sound Setup Menu screen.

Before performing the following procedures, see “About Time Correction” (page 29).

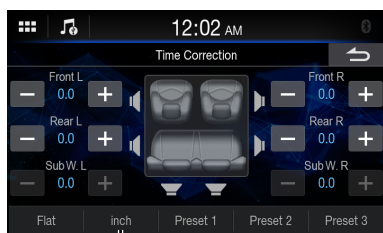

Correction mode

Setting item:

Time Correction

- 1 Touch [**Time Correction**] on the Sound Setup menu screen.
- 2 Touch the **Correction mode** button, and then select [**ms**], [**cm**] or [**inch**].
- 3 Touch [**-**] or [**+**] for each speaker to adjust the time or distance.
0.0 msec to 9.9 msec (0.1 msec/step)
0.0 cm (0.0 inch) to 336.6 cm (132.56 inch) (3.4 cm/step)
All speaker setting values are adjustable in the range of 20 ms or 680 cm.
- 4 To store the adjusted setting value, touch and hold [**Preset 1**], [**Preset 2**], or [**Preset 3**] for at least 2 seconds.

- Touch [**Flat**] to set all values to 0.0.
- If the Rear Speaker setting is Off, the Rear Speaker setting cannot be edited (page 28).
- If the Subwoofer setting is Off, the Subwoofer setting cannot be edited (page 27).

Calling the Time Correction Value

Calling the pre-set time correction value.

Touch [**Preset 1**], [**Preset 2**], or [**Preset 3**] on the time correction screen.

The setting stored in the Preset will be recalled.

Crossover Settings (X-Over)

[**X-Over**] is selected on the Sound Setup Menu screen.

Before performing the following procedures, see “About the Crossover” (page 28).



Setting item:

X-Over

- 1 Touch [**X-Over**] on the Sound Setup menu screen.
- 2 Touch [**Channel**], and then select [**Front HPF**], [**Rear HPF**] or [**SubW.LPF**].
- 3 Adjust the crossover to your preference.

Selecting the Cut-Off Frequency

Touch [◀] or [▶] of “Freq.” (Frequency), and then select the cut-off frequency.

Setting contents:

20.0 / 25.0 / 31.5 / 40.0 / 50.0 / 63.0 / 80.0 (Initial setting)
/ 100.0 / 125.0 / 160.0 / 200.0 Hz

Adjusting the Slope

Touch [◀] or [▶] of “Slope”, and then adjust the HPF or LPF slope.

Setting contents:

0 (Initial setting) / 6 / 12 / 18 / 24 dB/oct.

Adjusting the Level

Touch [**-**] or [**+**] of “Level”, and then adjust the HPF or LPF level.

Setting contents:

-12 to 0 dB (Initial setting: 0)

- 4 Repeat steps 2 to 3 to make adjustment to the other channels.
- 5 To store the adjusted setting value, touch and hold [**Preset 1**], [**Preset 2**], or [**Preset 3**] for at least 2 seconds.

- Touch [**Flat**] to initialize all values.
- If the Rear Speaker setting is Off, the Rear Speaker setting cannot be edited (page 28).

- If the Subwoofer setting is Off, the Subwoofer setting cannot be edited (page 27).
- While adjusting the X-Over you should consider the frequency response of the connected speakers.

Calling the X-Over adjusted value

Touch [Preset 1], [Preset 2], or [Preset 3].

The setting stored in the Preset will be recalled.

Volume Setup

[Volume] is selected on the Sound Setup menu screen.

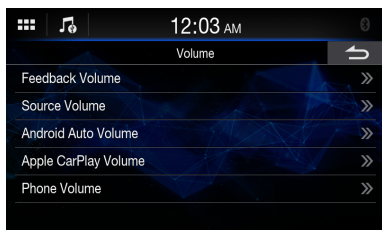

Setting items:

- Feedback Volume (page 27)
- Source Volume (page 27)
- Android Auto™ Volume (page 27)
- Apple CarPlay Volume (page 27)
- Phone Volume (page 27)

- *Settable source differs depending on the connected device and settings.*

Adjusting the Key Sound

You can change the volume of the sound heard when a button is touched.

Setting item:

Feedback Volume

Setting contents:

0 to 7 (Initial setting: 4)

Adjusting the Source Volume

Touch [Source Volume] on the Volume Setup menu screen.

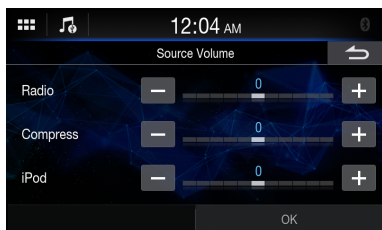

Setting item:

Radio / Compress* / iPod / Bluetooth Audio / Sirius XM / HDMI / AUX / Factory Audio

Setting contents:

-5 to +5 (Initial setting: 0)

- * Compressed Media is the music data in a USB flash drive (MP3/WMA/AAC/FLAC/WAV).

Setting the Volume for Android Auto™

When an Android Smartphone is connected, touch [Android Auto Volume] to set the volume for Android Auto mode.

Setting item:

Entertainment / Notification

Setting contents:

Entertainment: -5 to +5 (Initial setting: 0)
Notification: 0 to 35 (Initial setting: 10)

Setting the Volume for Apple CarPlay

When an iPhone 5s or later is connected, touch [Apple CarPlay Volume] to set the volume for Apple CarPlay mode.

Setting item:

Entertainment / Notification / Ringtone / Phone Calls

Setting contents:

Entertainment: -5 to +5 (Initial setting: 0)
Notification: 0 to 35 (Initial setting: 10)
Ringtone: 0 to 11 (Initial setting: 5)
Phone Calls: 0 to 11 (Initial setting: 5)

Adjusting the Volume for Phone

You can adjust the speaker volume and receive volume, during the call.

Setting item:

Speaker Volume / Mic Level / Ringtone Volume

Setting contents:

Speaker Volume: 0 to 11 (Initial setting: 5)
Mic Level: 1 to 11 (Initial setting: 7)
Ringtone Volume: 0 to 11 (Initial setting: 5)

Turning Subwoofer ON/OFF

If an optional subwoofer is connected to the unit, make the following setting.

Setting item:

Subwoofer

Touch [] (Off) or [] (On) of "Subwoofer".

Rear Speaker Setting

You can set the rear speaker output to Off.

Setting item:

Rear Speaker

Touch [] (Off) or [] (On) of "Rear Speaker".

Defeat Setting

If Defeat is On, the Equalizer setting are turned Off. This disables any settings made for these functions.

Setting item:

Defeat

Touch [] (Off) or [] (On) of "Defeat".

About the Crossover

Crossover (X-Over):

This unit is equipped with an active crossover. The crossover limits the frequencies delivered to the outputs. Each channel is controlled independently. Thus, each speaker pair can be driven by the frequencies for which they have been optimally designed.

The crossover adjusts the HPF (high pass filter) or LPF (low pass filter) of each band, and also the slope (how fast the filter rolls off the highs or lows).

Adjustments should be made according to the reproduction characteristics of the speakers. Depending on the speakers, a passive network may not be necessary. If you are unsure about this point, please consult your authorized Alpine dealer.

	Cut-off frequency (1/3 octave steps)		Slope		Level
	HPF	LPF	HPF	LPF	
Subwoofer (LPF)	----	20 Hz - 200 Hz	----	0, 6, 12, 18, 24 dB/oct.	0 to -12 dB
Rear speaker (HPF)	20 Hz - 200 Hz	----	0, 6, 12, 18, 24 dB/oct.	----	0 to -12 dB
Front speaker (HPF)	20 Hz - 200 Hz	----	0, 6, 12, 18, 24 dB/oct.	----	0 to -12 dB

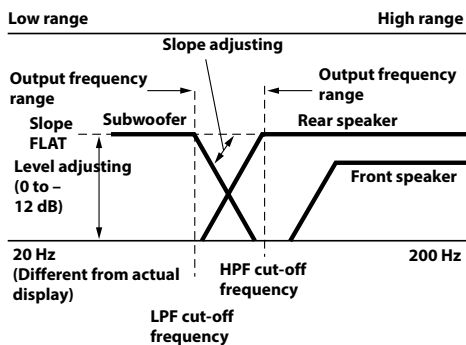

- HPF (high pass filter): Cuts the lower frequencies and allows the higher frequencies to pass.
- LPF (low pass filter): Cuts the higher frequencies and allows the lower frequencies to pass.
- Slope: The level change (in dB) for a frequency change of one octave.
- The higher the slope value, the steeper the slope becomes.
- Adjust the slope to FLAT to bypass the HP or LP filters.
- Do not use a tweeter without the HPF on or set to a low frequency, as it may cause damage to the speaker due to the low frequency content.

- *Adjustment should be made according to the recommended crossover frequency of the connected speakers. Determine the recommended crossover frequency of the speakers. Adjusting to a frequency range outside that recommended may cause damage to the speakers.*
For the recommended crossover frequencies of Alpine speakers, refer to the respective Owner's Manual.
We are not responsible for damage or malfunction of speakers caused by using the crossover outside the recommended value.

About Time Correction

The distance between the listener and the speakers in a car vary widely due to the complex speaker placement. This difference in the distances from the speakers to the listener creates a shift in the sounds image and frequency characteristics. This is caused by the time delay between the sound reaching the listener's right versus the left ear. To correct this, this unit is able to delay the audio signal to the speakers closest to the listener. This effectively creates a perception of increased distance for those speakers. The listener can be placed at an equal distance between the left and right speakers for optimum staging. The adjustment will be made for each speaker in 3.4 cm steps.

Example 1. Listening Position: Front Left Seat

Adjust the time correction level of the front left speaker to a high value and the rear right to zero or a low value.

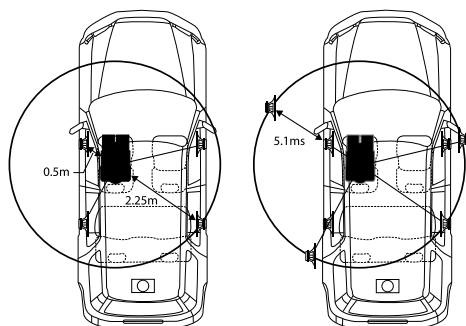

The sound is not balanced because the distance between the listening position and the various speakers is different. The difference in distance between the front left speaker and the rear right speaker is 1.75 m (68-7/8"). Here we calculate the time correction value for the front left speaker in the diagram on the above.

Conditions:

Farthest Speaker – listening position : 2.25 m (88-9/16")

Front left speaker – listening position : 0.5 m (19-11/16")

Calculation: $L = 2.25 \text{ m} - 0.5 \text{ m} = 1.75 \text{ m} (68-7/8")$

Time correction = $1.75 \div 343 * \times 1,000 = 5.1 \text{ (ms)}$

* Speed of sound: 343 m/s (765 mph) at 20°C

In other words, giving the front left speaker a time correction value of 5.1 ms makes it seem as if its distance from the listener is the same as the distance to the farthest speaker.

Time correction eliminates the differences in the time required for the sound to reach the listening position. The time of the front left speaker is corrected by 5.1 ms so that its sound reaches the listening position at the same time as the sound of other speakers.

Example 2. Listening Position: All Seats

Adjust the time correction level of each speaker to almost the same level.

- 1 Sit in the listening position (driver's seat, etc.) and measure the distance (in meters) between your head and the various speakers.**
- 2 Calculate the difference between the distance correction value to the farthest speaker and the other speakers.**

$L = (\text{distance to farthest speaker}) - (\text{distance to other speakers})$

These values are the time correction values for the different speakers. Setting these values to make each sound reach the listening position at the same time as the sound of other speakers.

Time Correction Value List

Time Difference (msec)	Distance (cm)	Distance (inch)	Time Difference (msec)	Distance (cm)	Distance (inch)
0.0	0.0	0.0	5.1	173.4	68.3
0.1	3.4	1.3	5.2	176.8	69.7
0.2	6.8	2.7	5.3	180.2	71.0
0.3	10.2	4.0	5.4	183.6	72.4
0.4	13.6	5.4	5.5	187.0	73.7
0.5	17.0	6.7	5.6	190.4	75.0
0.6	20.4	8.0	5.7	193.8	76.4
0.7	23.8	9.4	5.8	197.2	77.7
0.8	27.2	10.7	5.9	200.6	79.1
0.9	30.6	12.1	6.0	204.0	80.4
1.0	34.0	13.4	6.1	207.4	81.7
1.1	37.4	14.7	6.2	210.8	83.1
1.2	40.8	16.1	6.3	214.2	84.4
1.3	44.2	17.4	6.4	217.6	85.8
1.4	47.6	18.8	6.5	221.0	87.1
1.5	51.0	20.1	6.6	224.4	88.4
1.6	54.4	21.4	6.7	227.8	89.8
1.7	57.8	22.8	6.8	231.2	91.1
1.8	61.2	24.1	6.9	234.6	92.5
1.9	64.6	25.5	7.0	238.0	93.8
2.0	68.0	26.8	7.1	241.4	95.1
2.1	71.4	28.1	7.2	244.8	96.5
2.2	74.8	29.5	7.3	248.2	97.8
2.3	78.2	30.8	7.4	251.6	99.2
2.4	81.6	32.2	7.5	255.0	100.5
2.5	85.0	33.5	7.6	258.4	101.8
2.6	88.4	34.8	7.7	261.8	103.2
2.7	91.8	36.2	7.8	265.2	104.5
2.8	95.2	37.5	7.9	268.6	105.9
2.9	98.6	38.9	8.0	272.0	107.2
3.0	102.0	40.2	8.1	275.4	108.5
3.1	105.4	41.5	8.2	278.8	109.9
3.2	108.8	42.9	8.3	282.2	111.2
3.3	112.2	44.2	8.4	285.6	112.6
3.4	115.6	45.6	8.5	289.0	113.9
3.5	119.0	46.9	8.6	292.4	115.2
3.6	122.4	48.2	8.7	295.8	116.6
3.7	125.8	49.6	8.8	299.2	117.9
3.8	129.2	50.9	8.9	302.6	119.3
3.9	132.6	52.3	9.0	306.0	120.6
4.0	136.0	53.6	9.1	309.4	121.9
4.1	139.4	54.9	9.2	312.8	123.3
4.2	142.8	56.3	9.3	316.2	124.6
4.3	146.2	57.6	9.4	319.6	126.0
4.4	149.6	59.0	9.5	323.0	127.3
4.5	153.0	60.3	9.6	326.4	128.6
4.6	156.4	61.6	9.7	329.8	130.0
4.7	159.8	63.0	9.8	333.2	131.3
4.8	163.2	64.3	9.9	336.6	132.7
4.9	166.6	65.7			
5.0	170.0	67.0			

Apple CarPlay (Optional)

Apple CarPlay is a smarter, safer way to use your iPhone in the car. Apple CarPlay takes the things you want to do with your iPhone while driving and puts them right on the unit. You can get directions, make calls, send and receive messages, and listen to music, all in a way that allows you to stay focused on the road. Just plug in your iPhone to the unit and go.

- Before using this function, plug in your iPhone using Lightning to USB Cable (Supplied with iPhone) to the unit.
- Some functions may not be available while driving.
- About iPhone models usable with this unit, see "iPod mode on iPhone (Optional)" (page 39). Only an iPhone 5s or later compatible with Apple CarPlay function.
- Before operating Apple CarPlay, set "Apple CarPlay" to [On] (page 21).

Access to Apple CarPlay

1 Touch the (HOME) button.

The HOME screen is displayed.

2 Touch [Apple CarPlay].



[Apple CarPlay] button

The Apple CarPlay screen is displayed.
Touch the desired App icon on the unit, or use Siri function by touching the  button.

- When a used iPhone 5s or later is reconnected, touch the pop-up message- "Apple CarPlay connected." within 5 seconds to access to Apple CarPlay screen, or you can ignore prompt by touching [] on the top right.
- The App must be Apple CarPlay compatible in order to appear in the Home screen.

Android Auto (Optional)

What is Android Auto

Android Auto brings your favorite smartphone apps into one place, making it easier for drivers to access their favorite navigation, media, and communication apps on the road while minimizing the distractions. Talk to Google on Android Auto™ and get things done with your voice so you can keep your eyes on the road and hands on the wheel. Easily send messages, get directions, control media and more. Just say, "Hey Google" or long-press the voice control button on your steering wheel.

Activate Android Auto

Download the Android Auto App from the Google Play store before continuing.

Just plug in your smartphone to the unit's USB connector, then follow the prompt to pair your smartphone with the unit.

- The connected smartphone with Android Auto will disconnect other phone's Bluetooth connection and pair to the unit.

1 Touch the (HOME) button.

The HOME screen is displayed.

2 Touch [Android Auto].



[Android Auto] button

The Android Auto screen is displayed.

- When a used smartphone is reconnected, touch the pop-up message- "Android Auto connected" within 5 seconds to access to Android Auto screen, or you can ignore prompt by touching [] on the top right.
- You can make a call, use voice recognition function and Android Auto's compatible navigation app, etc.
- Only Google approved apps with necessary driver-safety measures in place can be used.

Radio/HD Radio™/RBDS

There are 3 types of [Radio] widgets for the HOME screen.

The unit can receive HD Radio broadcasting signals based on digital radio broadcast standards, in addition to analog radio broadcasts using RBDS.

HD Radio broadcasting signals are broadcast in the service areas of the current AM/ FM broadcasters where they provide digital audio distribution and data services. This unit receives the above digital broadcasts for your high-quality sound enjoyment.

Depending on the signal strength in TUNER mode, the unit will automatically switch between digital signals if they can be received, and analog radio using RBDS if digital signals cannot be received. For details, please see "Forced Analog Mode."

- RBDS mode is only available during FM broadcast reception.

This unit is able to receive signals based on the terrestrial digital radio broadcasting standard. When current AM/FM broadcasters are transmitting digital audio and data services, HD Radio broadcasting signals are on-the-air in their service area. You can receive their digital broadcast and enjoy high quality sound. If there is no HD Radio broadcasting signal in the current area, after 10 seconds, this unit will switch to receive the RBDS Radio signal automatically. However, the display is still HD Radio Technology mode screen.

■ HD Radio main screen example

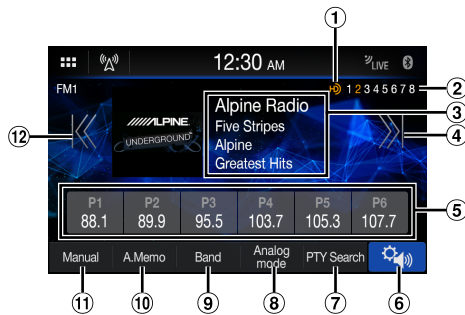

- 1 HD Radio indicator**
- 2 Multicast station channels indicator**
 - 1: MPS (Main Program Service)
 - 2-8: SIS (Station Information Service)
- 3 Information display**
 - For details on switching the display of the Radio text, see "Displaying Radio Text (HD Radio™, RBDS FM Radio mode only)" (page 34).
- 4 Increases frequency**
 - Touch and hold to change the frequency continuously.

- 5 IPreset button**
 - Displays the preset stations with a short touch.
 - Touch for at least 1 second to memorize the current station as a preset station.
- 6 Displays the Sound Setup Menu screen (page 24).**
- 7 PTY Search (RBDS FM Radio Mode only)**
- 8 Switch to analog mode.**
- 9 Switches a band.**
- 10 Memorizes stations automatically**
- 11 Switches a Seek mode.**
- 12 Decreases frequency**
 - Touch and hold to change the frequency continuously.

Radio Basic Operation

Listening to the Radio

- 1 Touch the [HOME] button and select radio mode.**
 - The display shows the radio mode screen.
- 2 Touch [Band] repeatedly to select the desired band from [FM1] / [FM2] / [AM].**
- 3 Touch [Seek], [Digital Seek], [Manual] or [PTY Seek] repeatedly to select the tuning mode.**
 - The radio frequency up or down button changes depending on the tuning mode.

Seek mode*	Both strong and weak stations will be tuned in.
Digital Seek mode	Automatically receives a receivable digital broadcast.
Manual mode	The frequency is manually tuned in steps.
PTY Seek mode (RBDS FM Radio Mode only)	The currently selected program type station will be tuned.

- During Forced Analog mode, digital broadcasts cannot be received.

* Depending on the signal, a digital or analog broadcast is received.

- 4 Touch [K], [J], [L], [R] to change the radio frequency up or down respectively.**

In Manual mode, touch and hold to change the frequency continuously.

Presetting Stations Manually

- 1 Tune in a desired radio station you wish to store in the preset memory by manual or automatic seek tuning.**
- 2 Touch and hold the Preset number you want to store for at least 1 second.**
- 3 Repeat the procedure to store up to 5 other stations onto the same band.**

The selected station is stored.

To use this procedure for other bands, simply select the desired band and repeat the procedure.

A total of 18 stations can be stored in the preset memory (6 stations for each band; FM1, FM2 or AM).

- *If a preset memory has already been set in the same preset number, it will be cleared and the new station will be memorized.*

Presetting Stations Automatically

The tuner can automatically seek and store 6 strong stations in the selected band in ascending order of frequency.

Select the desired band then touch and hold [A.Memo].

The tuner automatically seeks and stores 6 strong stations into the preset buttons in ascending order of frequency. When automatic storing has completed, the station stored in the preset 1 is selected.

- *If no stations are stored, the tuner will return to the original station you were listening to before the automatic storing procedure began.*
- *You can cancel this process by touching [A.Memo] while the tuner is automatically seeking stations. Canceling will return the tuner preset to the previous setting.*

Tuning to Preset Station

After selecting the desired band, touch the desired preset button.

The preset station is received.

Receiving a Multicast (HD Radio™ Mode only)

Multicasting is the ability to broadcast multiple program streams over a single FM frequency. This increases the amount and diversity of content choices. A maximum of 8 multicast station channels can be selected on this unit.

- *Multicast station channels indicator appears when signal reception is possible.*

Touch [⏪], [⏩] or [⏴], [⏵].

The sub channel of the received radio station is changed.

Forced Analog Mode

Activate the Compulsory Analog Radio mode to receive only analog radio signals.

Touch [Analog mode].

The [Analog mode] button is highlighted. To cancel Compulsory Analog Radio mode, touch [Analog mode] again.

- *During Forced Analog mode, only analog broadcasts will be received even when digital broadcasts become available.*

Selecting the Receivable Program Type (RBDS FM Radio Mode only)

You can select and receive the currently receivable stations in the Program Type list screen.

1 Touch [PTY Search]

The display shows the Program Type list screen.

2 Select the desired program type in the Program Type list screen.

Program Type Seek starts and the receivable program type is received.

If no Program Type station is found, "No program type available." will be displayed.

Using Ballgame Mode (HD Radio™ Mode only)

When [Ballgame Mode] is set to [On] (page 15), the LIVE indicator will light up when receiving live broadcast such as sportscast.

■ Ballgame mode screen example

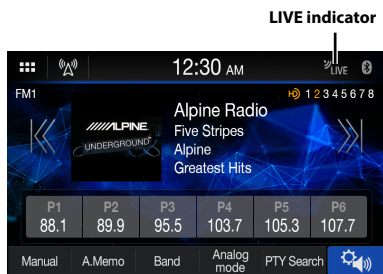

- In live broadcast, such as sportscasts, etc., a time lag occurs between digital sound and analog sound. Therefore, when live broadcasts are received, a time lag between the real broadcast may occur and the unit can change to analog broadcasting automatically.

Displaying Radio Text (HD Radio™/RBDS FM Radio mode only)

Text messages from a radio station can be displayed.

- 1 Tune in a radio station that transmits text messages.**
- 2 Touch the information display area in the FM radio mode repeatedly to switch to the desired display.**

RBDS:

Station Info Mode → Song Info Mode → Radio Text Mode → Station Info Mode

Station Info Mode:

PS / PTY / Frequency / Song Name

Song Info Mode:

PS/Song Name / Artist Name / Album Name

Radio Text Mode:

Radio Text

HD Radio:

Station Info Mode → Song Info Mode → Station Info Mode

Station Info Mode:

Station Name / Frequency / Song Name

Song Info Mode:

Station Name / Song Name / Artist Name / Album Name

About the Feature Logos

Digital Sound

- Digital, CD-quality sound. HD Radio Technology enables local radio stations to broadcast a clean digital signal. AM sounds like today's FM and FM sounds like a CD.

PSD

- Program Service Data: Contributes to the superior user experience of HD Radio Technology. Presents song name, artist, station IDs, HD2/HD3 Channel Guide, and other relevant data streams.

HD2/HD3

- Adjacent to traditional main stations are extra local FM channels. These HD2/HD3 Channels provide new, original music as well as deep cuts into traditional genre.

Artist Experience

- Visual information related to content being played on your HD Radio receiver, such as Album Art, historical photographs, still art from live broadcasts, among other related content.

USB Flash drive (Optional)

You can play back music files (MP3/WMA/AAC/FLAC/WAV), video files (MP4/AVI/WMV/MOV) and photo files (JPG/PNG/BMP) stored in a USB flash drive on the internal player of this system.

⚠ WARNING

It is dangerous for the driver to watch video while driving the vehicle. The driver may be distracted from looking ahead and an accident could occur.

Install the unit correctly so that the driver cannot watch a video unless the car is stopped and the parking brake is applied.

If the unit is not installed correctly, the driver will be able to watch a video while driving and may be distracted from looking ahead and cause an accident. The driver or other people could be severely injured.

USB Audio

■ USB Audio mode screen

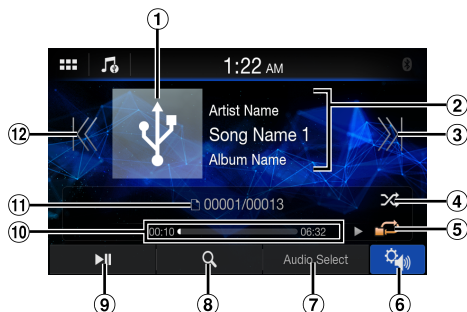

- ① Artwork display
- ② Information display
- ③ Finds the beginning of next chapter/Fast-forwards when touched for at least 1 second
- ④ Shuffle mode
- ⑤ Repeat mode
- ⑥ Displays the Sound Setup Menu screen (page 24)
- ⑦ Switches to iPod mode of iPhone or Bluetooth Audio.
- ⑧ Displays the search screen
- ⑨ Pause and Play
- ⑩ Elapsed time/Total time for playing
- ⑪ Current track number/Total track number
- ⑫ Finds the beginning of the current file/Finds a previous file within one second after playback starts/Fast-reverses when touched for at least 1 second

Playback

1 Touch the (HOME) button and select USB Audio mode.

The display shows the USB Audio mode screen.

2 Touch [] or [] to select the desired track (file).

Returning to the beginning of the current (or previous) track (file):

Touch [].

Fast reverse :

Touch and hold [].

Advancing to the beginning of the next track (file) :

Touch [].

Fast forward :

Touch and hold [].

3 To pause playback, touch [].

Touching [] again will resume playback.

- The playback time may not be correctly displayed when a VBR (Variable Bit Rate) recorded file is played back.
- If there is tag information, artist name/album name/track name is displayed.
- ID3 tag/WMA tag
If an MP3/WMA/AAC/FLAC/WAV file contains ID3 tag/WMA tag information, the ID3 tag/WMA tag information is displayed. (e.g., song name, artist name, and album name)
- When selecting a [Audio] widget on the HOME screen, touch [Audio Select] to select [USB]. If [USB] is already selected, you can start playback by selecting a [Audio] widget on the HOME screen.

Repeat Play

Touch [], [] or [] to select Repeat Play mode.



ALL : All files are repeatedly played back.

File : Only the file currently playing is repeatedly played back.

Folder : Only files in a folder are repeatedly played back.

Shuffle Play

Touch [] to select Shuffle Play mode.

- Folder  :** A Folder is selected randomly and songs in the Folder are played back in order. After all songs are played in a Folder, the next Folder is selected randomly.
- Song  :** All songs in the Folder (Folder/File) including the song currently being played are played back in random sequence.
- OFF  :** Shuffle mode is Off.

- If you select a track by using the search mode, the Shuffle mode will be canceled.

Searching for a Desired Song

1 Touch [] (Search).

2 Touch your desired Folder name or File name.

- When you select a Folder name, repeat the same procedure to select another Folder name or File name.
- Touch [**Shuffle Songs**] to randomly play back all songs in the USB flash drive.

USB Video

The video formats (USB Flash drive) supported by the unit are as follows.

- Supported Container: AVI/MP4/WMV/MOV/MPG
- Supported Video Coding: H.264/MPEG-4 AVC
- Supported Audio Coding: MP3, AAC, MPEG2 audio
- MAX File Size: 4GB

■ USB Video mode screen

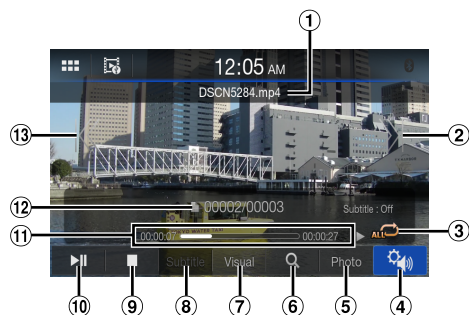

- ① File Name
- ② Finds the beginning of next file/Fast-forwards when touched for at least 1 second
- ③ Shuffle mode
- ④ Displays the Sound Setup Menu screen (page 24)
- ⑤ Switches to USB Photo mode
- ⑥ Displays the search screen
- ⑦ Sets the Brightness and Contrast
- ⑧ Displays the Subtitle
- ⑨ Stop
- ⑩ Pause and Play
- ⑪ Elapsed time/Total time for playing
- ⑫ Current file number/Total file number
- ⑬ Finds the beginning of the current file/Finds a previous file within one second after playback starts/Fast-reverses when touched for at least 1 second

Touch the (HOME) button and select USB Video mode.

The display shows the USB Video mode screen.

- To select USB Video mode, touch the [USB Video] or [Video] widget on the HOME screen.

During the USB Video playback, touch the screen to display the operation screen.

- For the basic operations on USB Video mode, refer to "Playback" (page 35).
- The operation screen changes to the visual screen in the USB Video mode for 5 seconds after an operation has been performed.
- For your safety, video is not displayed and only audio can be heard while driving.

Fast-forwarding/Fast-reversing

1 During playback, touch and hold [⏮] (Fast-reverse) or touch and hold [⏭] (Fast-forward).

Touch and hold for more than 1 second to forward/reverse by a 10 seconds interval.

2 Release [⏮] or [⏭] to return to normal playback.

- No sound is played back during fast-forwarding/fast-reversing.

Stopping Playback



Touch [■] during playback.

“STOP” indicator is displayed, and playback stops.

- Playback starts from the beginning when [▶] is touched while playback is stopped.

Repeat Play

Touch [ALL], [File] or [Folder] to select Repeat Play mode.

- ALL : All files are repeatedly played back.
- File : Only the file currently playing is repeatedly played back.
- Folder : Only files in a folder are repeatedly played back.

Searching for a Desired file

1 Touch [🔍] (Search).

2 Touch your desired Folder name or File name.

- When you select a Folder name, repeat the same procedure to select another Folder name or File name.
- Touch [Repeat videos] to repeatedly play back all videos in the USB flash drive.

Setting the Brightness and Contrast

1 Touch [Visual].

2 Touch [+] or [-] to adjust the Brightness and Contrast.

: Adjusting the Brightness

: Adjusting the Contrast

Displaying the Subtitle

Depending on the video file such as “smi” or “srt”, you can display the subtitle contained on the file.

Touch [Subtitle].

To cancel displaying the subtitle, touch [Subtitle] again.

- If the file is not supported or the subtitle is not contained on the file, [Subtitle] is not available.

USB Photo

■ USB Photo mode Preview screen



■ USB Photo mode screen

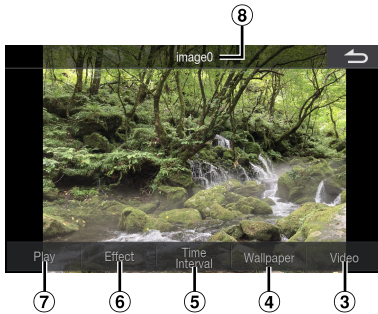

- ① Photo Preview
- ② Photo files List
- ③ Switches to USB Video mode
- ④ Sets the photo as a wallpaper (page 17)
- ⑤ Sets the Time Interval for the Slide Show
- ⑥ Applies an Effect to the photo
- ⑦ Plays the Slide Show
- ⑧ File Name

During the USB Photo playback, touch the screen to display the operation screen.

- The operation screen changes to the visual screen in the USB Photo mode for 5 seconds after an operation has been performed.

2 Select the desired photo from the photo files list.

- To select the other photo (file), touch [↔] to return to the previous screen.

Slide Show

The Slide Show shows photos that change every 3 seconds.

Touch [Play].

- To stop the Slide Show, touch the screen.

Setting the Effect for Playback

You can set the playback effect how switches to the photo for Slide Show.

Touch [Effect], and then select the desired effect.

Setting the Time Interval for Slide Show

You can set the time interval to switch to the next photo.

Touch [Time Interval], and then select the desired time interval.

Setting a Wallpaper with a Photo

To set a wallpaper with your favorite photo, refer to “Setting a Wallpaper using your image” (page 17).

Playback

1 Touch the (HOME) button and select USB Photo mode.

The display shows the USB Photo mode screen.

- To select USB Photo mode, touch the [Photo] or [Photo Frame] widget on the HOME screen.

iPod mode on iPhone (Optional)

A separately sold Lightning to USB cable (KCU-471i), etc., is required.

- This unit does not support video playback from iPhone which connected to this unit via USB Connector.
- Internet or telephone function, etc., of the iPhone is not controllable from the unit, but these functions can be controlled using the iPhone itself.
- Before operating iPod mode on iPhone, set "Apple CarPlay" to [Off] (page 21).

■ iPod main screen example

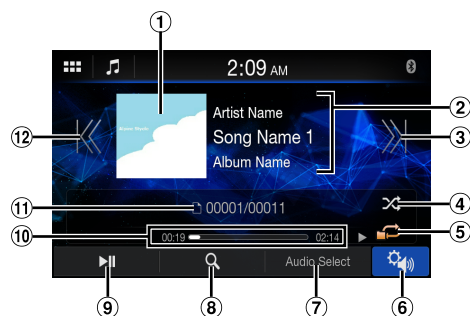

- ① Artwork display
- ② Information display*
- ③ Finds the beginning of the current file/Finds a previous file within one second after playback starts/Fast-reverses when touched for at least 1 second
- ④ Shuffle mode
- ⑤ Repeat mode
- ⑥ Displays the Sound Setup Menu screen (page 24).
- ⑦ Switches to the USB Flash drive or Bluetooth Audio.
- ⑧ Displays the search screen
- ⑨ Pause and Play
- ⑩ Elapsed time/Total time for playing
- ⑪ Current song no./Total song no.
- ⑫ Finds the beginning of the current file/Finds a previous file within one second after playback starts/Fast-reverses when touched for at least 1 second

* Podcast mode.

Playback

1 Touch the (HOME) button and select iPod mode.

The display shows the iPod mode screen.

2 Touch [] or [] or to select the desired track (file).

Returning to the beginning of the current (or previous) track (file):

Touch [].

Fast reverse the current track :

Touch and hold [].



Advancing to the beginning of the next track (file) :

Touch [].

Fast forward the current track :

Touch and hold [].

3 To pause playback, touch [].

- If a song is playing on the iPhone before it is connected to the unit, it will continue playing when it is connected.
- An episode may have several chapters. The chapter can be changed by touching [] or [].
- If the artist, album or song name, created in iTunes, has too many characters, songs may not be played back when connected to the unit. Therefore, a maximum of 64 characters is recommended. The maximum number of characters for the unit is 64.
- Some characters may not be correctly displayed.
- When selecting a [Audio] widget on the HOME screen, touch [Audio Select] to select [iPod]. If [iPod] is already selected, you can start playback by selecting a [Audio] widget on the HOME screen.

Searching for a Music File

An iPhone can contain thousands of songs. For this reason, this unit can make various searches using the search function as shown below.

Using the Playlist/Artist/Album/Podcast/Audiobook/Genre/Composer/Song/Radio search mode's individual hierarchy, you can narrow down your search as shown in the table below.

<Music Search Menu>

Hierarchy 1	Hierarchy 2	Hierarchy 3	Hierarchy 4
Playlists	Songs	—	—
Artists	Albums	Songs	—
Albums	Songs	—	—
Songs	—	—	—
Genres	Artists	Albums	Songs
Composers	Albums	Songs	—
Podcasts	Episodes	—	—
Audiobooks	—	—	—
Radio	—	—	—

For example: Searching by Artist name

The following example explains how an Artists search is performed.

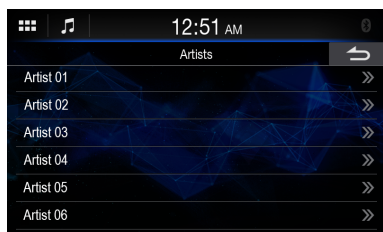

1 Touch [Q] (Search) during playback.

2 Touch [Artists].

The Artists search screen is displayed.

3 Touch the desired artist's name.

4 Touch the desired album's name.

All songs of the selected album are displayed.

5 Touch the desired song's name.

The selected song is played back.

Repeat Play

Touch [] to select Repeat Play mode.

ALL  : All files are repeatedly played back.

File  : Only the file currently playing is repeatedly played back.

OFF  : Repeat mode is Off.

Shuffle Play

Touch [] to select Shuffle Play mode.

Songs  : Song shuffle randomly plays back songs within a selected category (playlist, album, etc.). The songs within the category are played just once until all songs have been played.

OFF  : Shuffle mode is Off.

SiriusXM Satellite Radio Operation (Optional)

SiriusXM Tuner operation:

When an optional SiriusXM Tuner is connected to this unit, the following operations may be performed.

■ SiriusXM main screen example (Song Info. Mode)

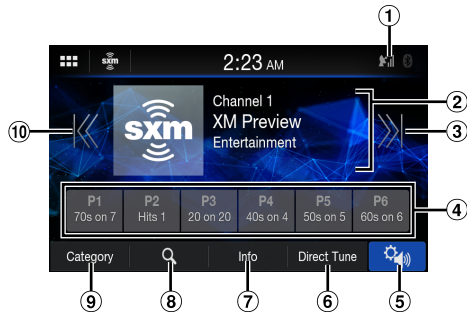

- ① Signal Indicator
Indicates the signal strength of SiriusXM.
- ② Information display
Channel Info. Mode:
Channel No./Long Channel Name/Category Name
Song Info.Mode:
Artist Name/Song Name/Content Info
- ③ Changes to the next channel
- ④ Preset buttons
Displays the preset channels with a short touch.
Touch for at least 1 second to memorize the current channel as a preset channel.
- ⑤ Displays the Sound Setup Menu screen (page 24).
- ⑥ Select the channel number
- ⑦ Changes text information
- ⑧ Displays the search screen
- ⑨ Changes to category browsing mode
- ⑩ Changes to the previous channel

Receiving Channels with the SiriusXM Tuner

About SiriusXM Satellite Radio

Only SiriusXM® brings you more of what you love to listen to, all in one place. Get over 140 channels, including commercial-free music plus the best sports, news, talk, comedy and entertainment. Welcome to the world of satellite radio. A SiriusXM Vehicle Tuner and Subscription are required. For more information, visit www.siriusxm.com.

After you have found the SiriusXM Radio ID, you can activate your radio. See "Checking the SiriusXM Radio ID Number" (page 42).

In the USA, you can activate online or by calling SiriusXM Listener Care:

- Visit www.siriusxm.com/activatenow
- Call SiriusXM Listener Care at 1-866-635-2349

For Canadian Subscriptions, please contact:

- Visit www.siriusxm.ca/activatexm
- Call XM Customer Care at 1-877-438-9677
- The SiriusXM Satellite Radio controls on this unit are available only when a SiriusXM Tuner is connected.

1 Touch the (HOME) button and select SiriusXM mode.

The display shows the SiriusXM mode screen.

2 Touch [] or [] to select the desired channel. Touching and holding either button will rapidly browse through the channels.

- Refer to the SiriusXM Tuner User Guide for details on how to install the SiriusXM Tuner.

Tuning Channels by Category

Channels are grouped into categories based on the type of content heard on the channels.

1 Touch [Category] on the SiriusXM main screen to activate the category browsing mode.

The channels within the category of the current channel are listed.

■ Category browsing mode screen example

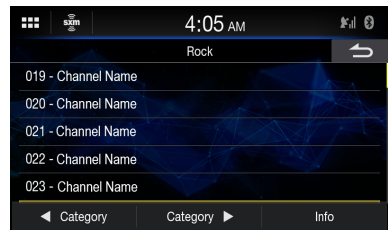

- Touching [Info] changes the display of information for the channels in the category with the following three options.

Channel No./Channel Name → Channel No./Artist Name → Channel No./Song Title → Channel No./Content Info → Channel No./ Channel Name

2 Touch [Category] or [Category] on the category browsing mode screen to select a desired category.

The Category Name is shown at the top of the display.

3 Select the desired channel.

Changing the Display

Text information, such as the channel name, artist name/feature, and song/program title, is available with SiriusXM. The unit can display this text information as explained below.

Touch [Info].

Each time you touch this button, the Channel Info. mode and the Song Info. mode switch alternately. For displayed contents, see "SiriusXM main screen example (Song Info. Mode)" (page 41).

Checking the SiriusXM Radio ID Number

To subscribe to the SiriusXM Satellite Radio service, it is necessary to locate and identify the Radio ID of your SiriusXM Tuner. You can check the Radio ID on the bottom surface of the SiriusXM Tuner box. You can also check it from this unit by performing the following procedure.

1 While receiving SiriusXM Radio, touch [K] or [J] to select channel "0".

The unit displays the Radio ID number.

2 To cancel the Radio ID number display, change the channel to a channel other than "0".

- *The SiriusXM Radio ID does not contain the letters I, O, S, or F.*

Storing Channel Presets

You can store 6 of your favorite SiriusXM channels for easy recall with Preset buttons.

1 Touch and hold the Preset number you want to store for at least 1 second to store the channel.

2 Repeat the procedure to store up to 5 other channels.

A total of 6 channels can be stored in the preset memory.

- *If you store a new channel into a preset which already has a channel assigned, the current channel will be cleared and replaced with the new one.*

Tuning Channels using Presets

Touch any one of the Preset numbers you have already stored in the Preset mode screen.

The preset channel is received.

Search Function

1 Touch [Q].

The Search list screen appears.

Search item:

All Channels / Category Name*

- * The Category name for the channel currently being received is displayed.

- *You can switch the category by touching [◀] or [▶] on the List screen after selecting a Search item.*
- *You can switch the display format by touching [Info] in the List screen after selecting a Search item.*
Channel No./Channel Name → Channel No./Artist Name → Channel No./Song Title → Channel No./Content Info → Channel No./Channel Name

Searching by Channel

2 Touch [All Channels].

All Channels will be displayed in a list.

3 Touch the selected channel.

The channel you selected is received.

Searching by Category

2 Touch Category Name.

The channels within the category of the current channel are listed.

3 Touch the selected channel.

The channel you selected is received.

Selecting the Channel Directly

You can directly select the channel number by using the numeric keypad.

1 Touch [Direct Tune].

The numeric keypad input screen is displayed.

2 Touch to input the channel number.

3 Touch [OK].

The selected channel is received.

Parental Lock Function

The Parental Control feature allows you to limit access to any SiriusXM channels, including those with mature content. When enabled, the Parental Control feature requires you to enter a passcode to tune to the locked channels. For information on setting the Parental Control passcode, see “Setting the Parental Lock” (page 15). When a locked channel is selected, “Channel <xxx> Locked” is displayed and then the numeric keypad appears for you to enter the passcode.

Input the 4-digit passcode you set in “Setting the Parental Lock” (page 15).

The initial number is 0000.

- *If you input a wrong passcode, “Incorrect Pass Code entered” is displayed.*
- *After entering the correct passcode, you can access all locked channels without entering the passcode again until the unit is powered off and then back on.*

HDMI Device (Optional)

Devices supporting HDMI can connect and play back through this unit (for example, an optional DVD Player, iPhone or other Smartphones).

- *The HDMI/MHL connecting cable differs depending on the connected device corresponding to HDMI. Prepare optional HDMI/MHL connecting cable sets suitable for your device.*

HDMI Operation

■ iPhone, Smartphone, etc.

The output of your electronic device will be mirrored on this unit through the HDMI connector. Control from this unit is not possible.

- *The electronic device must possess an HDMI output interface.*
- *Not all devices with an HDMI output interface can be recognised by this unit.*
- *Use only the Alpine Special HDMI connection cable.*

1 Touch the (HOME) button to select HDMI.

The display shows the HDMI mode screen.

- *You can select and change the source in the HOME screen (page 12).*
- *For your safety, video is not displayed and only audio can be heard while driving.*

2 In HDMI player mode, the screen of the device displays the content of electronic equipment by mirror image.

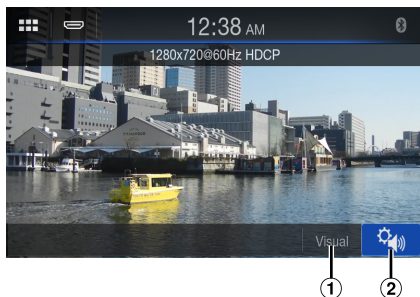

① Sets the Brightness and Contrast

② Displays the Sound Setup Menu screen (page 24).

Setting the Brightness and Contrast

1 Touch [Visual].

2 Touch [+] or [-] to adjust the Brightness and Contrast.

 : Adjusting the Brightness

 : Adjusting the Contrast

Bluetooth Operation

Setup Before Using

About Bluetooth

Bluetooth is a wireless technology allowing communication between a mobile device or personal computer over short distances. This enables a hands-free call or data transmission between Bluetooth compatible devices. Bluetooth transmission is available in the unlicensed 2.4 GHz spectrum if the distance between devices is within 10 meters. For details, refer to the Bluetooth website (<http://www.bluetooth.com/>).

- Depending on the Bluetooth version, a Bluetooth compatible device may not be able to communicate with this unit.
- Proper function of this unit with all Bluetooth compatible devices is not guaranteed. For handling of the Bluetooth compatible device, consult your Alpine dealer or Alpine website.
- Depending on the surroundings, Bluetooth wireless connection may be unstable.
- When you place a call, or perform setup operations, be sure to stop your car in a safe place.
- Depending on the connected Bluetooth compatible device(s), the function may differ. Also refer to the Owner's Manual of the connected device(s).

About the Hands-free Phone

Hands-free calls are possible when using a HFP (Hands-Free Profile) compatible mobile phone with this unit.

- Avoid performing a hands-free call in heavy traffic or on narrow or winding streets.
- Close the windows while calling to reduce background noise.
- If both calling parties are using hands-free devices, or the call is made in a noisy location, difficulty hearing the other person's voice is normal.
- Depending on telephone line conditions or certain mobile devices used, voices may sound unnatural.
- When using a microphone, speak as directly as you can into the microphone to obtain the best sound quality.
- Certain mobile phone features are dependent on the capabilities and settings of your service provider's network. Additionally, certain features may not be activated by your service provider, and/or the provider's network settings may limit the feature's functionality. Always contact your service provider about feature availability and functionality. All features, functionality, and other product specifications, as well as the information contained in the Owner's Manual are based upon the latest available information and are believed to be accurate at the time of printing. Alpine reserves the right to change or modify any information or specifications without notice or obligation.
- Notice that when you connect an iPhone 5s or later/Android smartphone which installed Android Auto App, the operation screen may differ from this section.

Before Using Bluetooth

Before using the hands-free phone/audio function, the following settings need to be made.

Register a Bluetooth device in this unit.

- See "Connection (Bluetooth) Setup" (page 20).
- You can search for this unit using a Bluetooth compatible device, and then connect that Bluetooth compatible device to this unit. The device name of this unit is "iLX-407" and the initial number of the passcode is "0000." Also refer to the Owner's Manual of the connected device(s).

Hands-free Phone Control

Touch the Phone button to display the Phone menu screen.



Phone button

- You can also display the Phone menu screen by selecting the [Phone] widget on the HOME screen.

Phone menu screen example

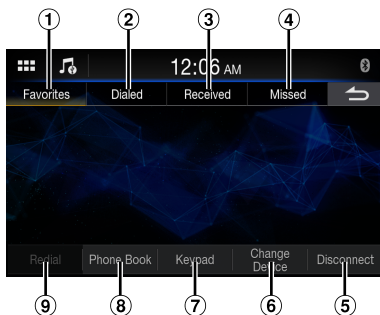

- ① Favorite
Displays a list of numbers set as your favorite.
- ② Dialed
Displays a list of dialed calls.
- ③ Received
Displays a list of the received calls.
- ④ Missed
Displays a list of the missed calls.

- ⑤ **Disconnect**
Disconnects the Bluetooth device. After disconnecting, the display changes to **[Reconnect]** to connect the disconnected device again.
- ⑥ **Change Device**
Displays the Bluetooth Setup screen.
- ⑦ **Keypad**
Use to type a phone number.
- ⑧ **Phone Book***
You can make a phone call from the Phone Book, or edit the Phone Book.
- ⑨ **Redial**
Dials to the last called number.

* If the Hands-Free Phone is not connected, the Bluetooth Setup screen will be displayed. See "Connection (Bluetooth) Setup" (page 20).

Answering a Call

- 1 **An incoming call triggers the ringtone and an incoming call display.**

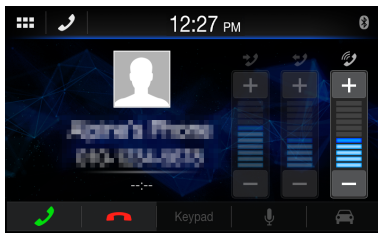

- You can adjust the ringtone volume by touching [+] or [-] of "Ringtone Volume (🔊)".

- 2 **Touch [📞].**

The call starts.

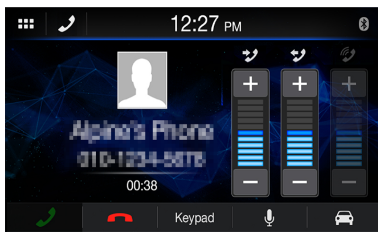

- During a call, the audio for the current mode on the unit is muted. After calling, playback will resume.
- When the caller's number is transmitted to the system, if the caller's name is stored in the phone book, the name is displayed. If the name is not stored, the number is displayed.
- Touch [📞] (Decline) to reject an incoming call.
- By touching [🔇], you can mute the microphone. To cancel MUTE mode, touch [🔊]. For details, see "Phone Operation Screen" (page 48).
- If another call comes during a call, operate on the Bluetooth Device.

Hanging up the Telephone

- 1 **Touch [📞] (End Call).**

The call finishes.

Calling

Making a phone call using the Phone Menu

Making a phone call from the Recent Events list

- 1 **Select a category from [Favorite], [Dialed], [Received] or [Missed] on the Phone menu.**

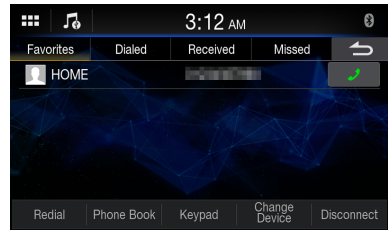

- 2 **Touch [📞] of the name or number of the contact which you want to call.**

- 3 **Touch [Call].**

The phone call is started.

- To use [Favorite], see "Setting contacts as Favorites (Shortcut Dialing)" (page 49).

Calling from the Phone Book

- 1 **Touch [Phone Book] on the Phone menu.**

The Phone Book screen appears.

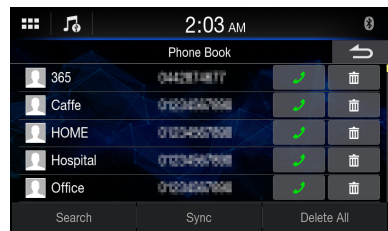

- 2 **Touch [📞] of the name or number of the contact which you want to call.**

The phone call is started.

Entering a Phone Number to Make a Call

1 Touch [Keypad] on the Phone menu.

The number input screen (Keypad) appears.

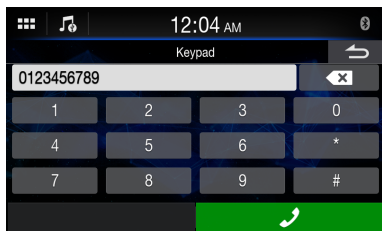

Touch [X] to delete an entered number.

2 Enter the phone number you wish to call.

- You can enter up to 21 digits.

3 Touch [Call] (Call).

A confirmation message of the phone number appears.

4 Touch [Call].

The phone call is started.

Calling in Private

When using the Private Call setting, the conversation is not output through the speaker.

Touch [Change Device] during the call.

- To change the Bluetooth device, touch [Change Device] to display the Bluetooth Setup screen. See "Connection (Bluetooth) Setup" (page 20).

Using Voice Recognition function

You can use Siri function of your iPhone or make a telephone call by using voice operation of your smartphone.

- When using Apple CarPlay or Android Auto, the operation screen may differ from the screen design in the Owner's Manual.

Using Siri

You can use the Siri function of your iPhone. To use this function, set the Siri setting of your iPhone to ON.

- Connect your iPhone to the unit via Bluetooth, then set to "Hands-free" (page 20).
- The available functions differ depending on the connected iPhone.
- Ask Siri to play a track from the music library applies only to USB source.
- Siri and other streaming services are enabled by connecting to compatible smartphones that are able to receive data. Please ensure that cellular data and/or Wi-Fi is turned on in the smartphone to enjoy these features.

- Extensive use of Siri or other streaming services may increase your phone's data usage. Please check with your phone company to ensure you have an appropriate Data plan.

1 Touch [Voice Recognition] button.

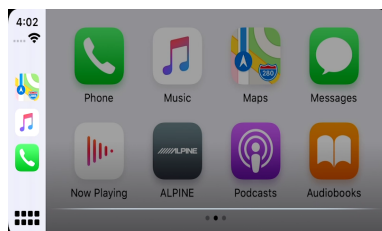

The Voice Recognition mode screen is displayed.

2 Speak into the microphone supplied with this unit.

3 To finish the Voice Control mode, touch [Cancel].

- Depending on the iPhone, the Siri function may finish automatically.
- For adjusting the volume, see "Adjusting the Speech Volume" (page 48).

Voice Dial Function

You can make a telephone call by using voice operation.

- Connect your smartphone to the unit via Bluetooth, then set to "Hands-free" (page 20).

1 Touch [Voice Recognition] button.

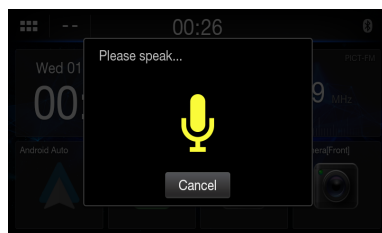

The Voice Dial mode screen is activated.

2 Say the telephone number* or name* you want to call, into the microphone.

* The number and name depend on the voice dial information stored in the smartphone.

3 To finish the Voice Dial mode, touch [Cancel].

- You can perform this operation only when a voice dial compatible smartphone is connected.
- The Voice Dial function performance depends on the recognition range of the smartphone and mounting location of the microphone.
Note when the microphone is mounted.

- Voice dial operation depends on the function being available on the smartphone. For details, refer to the owner's manual of the smartphone.
- Depending on the smartphone, the Voice Dial operation may finish automatically.
- For adjusting the volume, see "Adjusting the Speech Volume" (page 48).

Phone Operation Screen

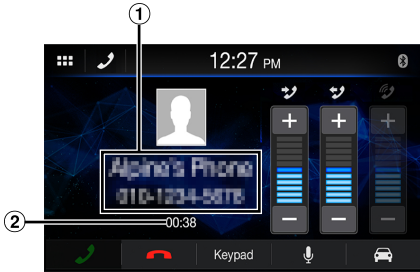

- ① Name and phone number
 - If it is registered with a Group, the Group Name is also displayed. Although, depending on the connected mobile phone, it may not be displayed.
- ② Conversation time

Adjusting the Speech Volume

You can adjust Caller Level and Microphone Level.

Touch [-] or [+] of "Speaker Volume (🔊)" or "Mic Level (🔊)".

You can adjust the volume in 11 levels.

Changing the Voice Output

The voice output for calls is switchable between car speakers and the mobile phone speaker.

Touch [📱] or [🚗].

- Depending on the mobile phone, this operation may not be possible.

Muting the Microphone

Touch [🚫].

- To cancel MUTE mode, touch [🚫].

DTMF (Touch-Tone) Function

Transmits a DTMF (Touch-Tone) during a call.

1 Touch [Keypad].

The number input screen (Keypad) appears.

2 Input number.

- You can transmit a Touch-Tone signal during a call.

Phone Book Function

Phone Book screen example

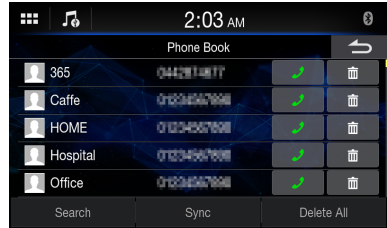

Searching in the Phone Book

You can make a call using the phone book search function.

1 Touch [Search] on the Phone Book screen.

The Input User Name screen (Keypad) is displayed.

2 Input the string of letters of the name that you want to search, then touch [OK].

A list of names beginning with the string of letters you entered is displayed.

3 Touch [📞] of the name or number of the contact which you want to call.

The phone call is started.

- If there are fewer than five registered items in the phone book, you cannot use the phone book search function.

Synchronizing the Phone Book

You can synchronize the system's phone book with the mobile phone's phone book.

1 Touch [SYNC] on the Phone Book screen.

The confirmation screen is displayed.

2 Touch [Yes].

Synchronization of the phone books starts.

- You can store up to 1,000 registered name in the phone book.
- You can store up to 5 phone numbers by one person's name.

Deleting the Phone Book Entries

Deleting One Entry from the Phone Book

Touch [] of the contact name (or phone number) you want to delete.

The selected number is deleted.

Deleting All Entries from the Phone Book

1 Touch [Delete All] on the Phone Book screen.

The confirmation screen is displayed.

2 Touch [Yes].

All entries of the phone book are deleted.

Setting contacts as Favorites (Shortcut Dialing)



You can set contacts from the Phone Book, Dialed, Received, and Missed list as favorites.

1 Touch the name or phone number on the list.

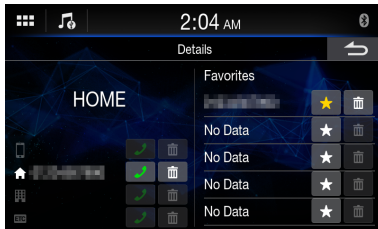
2 Touch [] of "Favorites."



The phone number is set as a Favorite.

- Up to 5 contacts can be set as Favorites.
- If [] has already been set with a number, touching it overwrites the number.
- To delete a contact from the Favorites list, touch [].

Bluetooth Audio

If a Bluetooth compatible mobile phone, portable player, etc. is connected by wireless, you can play back a song (operation is controllable from the unit).

- Operation may vary, depending on the Bluetooth compatible device.

Bluetooth Audio main screen example



- ① Information display
- ② Finds the beginning of next chapter/Fast-forwards when touched for at least 1 second
- ③ Shuffle mode
- ④ Repeat mode
- ⑤ Displays the Sound Setup Menu screen (page 24).
- ⑥ Switches to the USB Flash drive or iPod mode of iPhone.
- ⑦ Disconnects the Bluetooth device
- ⑧ Changes the Bluetooth device.
- ⑨ Pause and Play
- ⑩ Elapsed time/Total time for playing
- ⑪ Current track number/Total track number
- ⑫ Finds the beginning of the current file/Finds a previous file within one second after playback starts/Fast-reverses when touched for at least 1 second

- The displayed onscreen buttons may differ depending on the AVRCP version.
- Song title/Artist title/Album title/Elapsed time do not display for AVRCP Ver. 1.0.
- To play back audio, a mobile phone or a portable player conforming to A2DP (Advanced Audio Distribution Profile) or AVRCP (Audio/Video Remote Control Profile) is required. Not all functions work with all devices.
- During a call, sound on the Bluetooth audio source is paused.

Compatible AVRCP versions: 1.0, 1.3, 1.4, 1.5

- Available functions may differ depending on the AVRCP version.

Playback

1 Touch the (HOME) button and select Bluetooth Audio mode.

The display shows the Bluetooth Audio mode screen.

2 Touch [] or [] to select the desired track (file).

Returning to the beginning of the current file:

Touch [].

Fast backward the current file:

Touch and hold [].

Advance to the beginning of the next file:

Touch [].

Fast forward the current file:

Touch and hold [].



3 To pause playback, touch [].

- When selecting a [Audio] widget on the HOME screen, touch [Audio Select] to select [BT]. If [BT] is already selected, you can start playback by selecting a [Audio] widget on the HOME screen.

Repeat Play

Available for AVRCP Ver. 1.4 and 1.5 only.

Touch [] repeatedly to select Repeat Play mode.



- File : Only the track currently playing is repeatedly played back.
- ALL : Once all of the songs have finished playing, play back is repeated, starting with the first song.
- Off : Repeat mode is Off.

- Operations may differ depending on the connected Bluetooth compatible device.

Shuffle Play

Available for AVRCP Ver. 1.4 and 1.5 only.

Touch [] to select Shuffle Play mode.

- ALL : All songs in the Bluetooth compatible devices are played back in random sequence. Any one song does not play back again until all songs have been played back.
- Off : Shuffle mode is Off.

- Operations may differ depending on the connected Bluetooth compatible device.

Connecting a Bluetooth Device

Registering a Bluetooth device in the unit enables automatic connection.

If it does not connect automatically, run through the connection procedure again.

Touch [Reconnect] on the Bluetooth Audio screen.

The Bluetooth connection will start.

Disconnecting the Bluetooth Connection

Touch [Disconnect] on the Bluetooth Audio screen.

The Bluetooth connection is disconnected.

Switching the connecting Bluetooth Device

If multiple Bluetooth devices are registered in this device, you can change the connection among the registered devices.

1 Touch [Change Device] on the Bluetooth Audio screen.

2 Touch the device name.

The connection will transfer to the selected device.

Auxiliary Device (Optional)

Operating Auxiliary Devices (Optional)

To operate devices connected to the AUX terminals of the unit, follow the procedure described below.

- Set up the “AUX Setup” (page 16).
- Depending on the connected unit, the onscreen buttons may not work, or their operation may differ.
- When the iDataLink module (sold separately) is connected, the Auxiliary (AUX) mode is not available.

WARNING

It is dangerous (and illegal in many states) for the driver to watch video while driving the vehicle. The driver may be distracted from looking ahead and an accident could occur.

Install the unit correctly so that the driver cannot watch video unless the car is stopped and the parking brake is applied.

If the unit is not installed correctly, the driver will be able to watch video while driving and may be distracted from looking ahead and cause an accident. The driver or other people could be severely injured.

1 Touch the (HOME) button to select Auxiliary (AUX) mode.

The display shows the Auxiliary (AUX) mode screen.

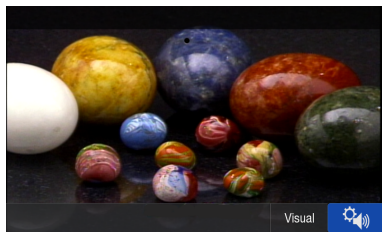



- When AUX Select is set to “Factory Media + Drive Recorder”, only the video will be displayed. Audio will not be played. For details, see “Setting the AUX Select” (page 16).
- For your safety, video is not displayed and only audio can be heard while driving.
- For details on the connected auxiliary device, refer to its owner’s manual.

Setting the Brightness and Contrast

1 Touch [Visual].

2 Touch [+] or [–] to adjust the Brightness and Contrast.

 : Adjusting the Brightness

 : Adjusting the Contrast

Camera Operation (Optional)

When an optional camera is connected, the view video of camera can be output to the monitor.

Rear camera:

If a rear camera is connected, when the vehicle is reversed, the rear camera view (guide marks for vehicle width and available distance) is displayed automatically on the screen of this unit.

Front camera:

If a front camera is connected, it can assist to check the condition in front of the car, such as when the road visibility is bad.

You can adjust the quality of the camera image.
Setting items: Brightness / Color / Contrast
See “Camera Picture Quality Setup” (page 22).

Rear Camera Operation

Displaying the Camera Image from the HOME screen

1 Touch the (HOME) button.

The HOME screen is displayed.



[Camera[Rear]] button

- If [Camera Select] in the Rear Camera setting is set to [Off] (page 21), the [Camera[Rear]] button cannot be selected.

2 Touch [Camera[Rear]].

The Rear Camera view image is displayed.

- Touch  to return to the main source screen or previous screen.
- You can perform a Guide Adjustment for the rear view image. For details, see “About the Rear Camera Guide” (page 52).

Displaying the rear view video while the car is in reverse

1 Shift the gear lever to the reverse (R) position.

The rear view image is displayed while the car remains in reverse.

2 If you shift the gear lever to a position other than reverse (R), the monitor returns to the previous screen.

- Never depend solely on the camera when backing up. Always turn and look and only use the camera for additional assistance.
- This function is effective when the reverse wire is properly connected.
- Touch  to return to the main source screen or previous screen.
- You can perform a Guide Adjustment for the rear view image. For details, see “About the Rear Camera Guide” (page 52).

About the Rear Camera Guide

To display the guide, set “Turning the Rear Camera Guide On/Off” (page 22) to On. Also, to adjust the guide, see “Rear Camera Guide Settings” (page 22).

■ Indication mark meaning

When the car is put into reverse gear, the monitor switches to the rear view camera image. Guides appear to help visualize the car's width and distance from the rear bumper.

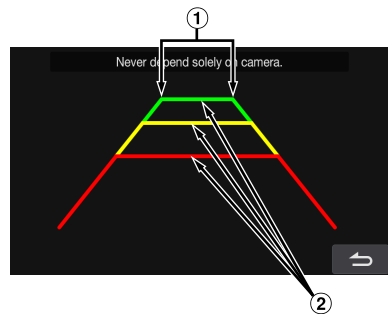

① Car width extension lines (red, yellow and green in order of distance)

If properly calibrated, the marks indicate the car's width. This helps guide the car's path when backing up in a straight line.

The marks represent the distance from the rear of the car (from the rear end of the bumper).

- The marks do not move in synchronization with the steering wheel.
- Set the marks to suit the car's width.

② Distance guidance lines

The marks represent the distance from the rear of the car (from the rear end of the bumper).

- The marks do not move in synchronization with the steering wheel.
- We recommend that you measure the actual distance to the marks when parked on a level surface.
- Depending on the condition of the car or road surface, the range of vision may vary.
- The camera has a limited range of vision. Objects at extreme angles to the camera (e.g. under the bumper or at opposite ends of the bumper) may not be in its field-of-vision.
- The rear camera image may have a tint which is different from the actual surroundings.
- Depending on the car, the guidance may deviate to the right or left. This is not a malfunction.

■ Distance guidance mark

The distance guides represent the ground level distance from the rear bumper. It is difficult to accurately estimate the distance to objects above ground level.

In the following example, the distance to A is 0.5 m and the distance to B is 1 m.

<Screen>

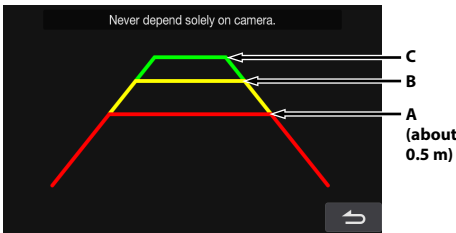

<Positions of A, B and C>

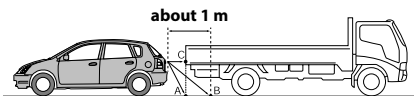

In the screen, according to the distance guidance marks, the truck seems to be parked about 1 m away (at the position B). In actual fact, however, if you reversed to position A, you would collide with the truck.

In the screen, positions A, B and C seem to be located in order of proximity. However, in actual fact, the position A and C are the same distance, and B is farther away than positions A and C.

- The car width extension mark represents the distance to the road surface. The distance to an object on the road is not accurately represented by the guides.

Error between the screen and the actual road surface

In the following conditions, errors are produced between the screen guidance and the actual road surface. (The illustrations represent a case when the camera is installed in the standard position.)

■ When there is a steep upward slope behind the car (example)

<Screen>

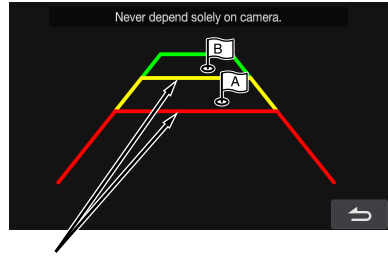

Distance guidance marks

<Situation of the car>

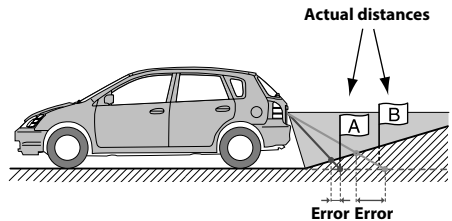

The distance guidance mark represents the distance to a flat road surface. Therefore in the case of an upward slope behind the car, the distance guides are displayed closer to the rear bumper than the actual distance. For example, if there is an obstacle on the upward slope, it may appear farther away than its actual position.

Also, an error may occur between the guidance and the actual path of the car on the road surface.

■ **When there is a steep downward slope behind the car (example)**

<Screen>

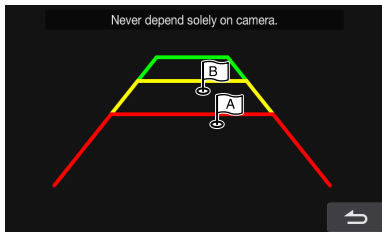

<Situation of the car>

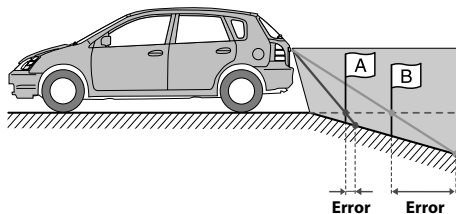

In the case of a downward slope behind the car, the distance guides are displayed farther from the rear bumper than the actual distance.

If there is an obstacle on the downward slope, it seems closer than its actual position.

Also, an error may occur between the guidance and the actual path of the car on the road surface.

Front Camera Operation

Displaying the Camera Image from the HOME screen

1 Touch the  (HOME) button.

The HOME screen is displayed.



[Camera[Front]] button

- If [Camera Select] in the Front Camera setting is set to [Off] (page 23), the [Camera[Front]] button cannot be selected.

2 Touch [Camera[Front]].

The Front Camera view image is displayed.

- Touch  to return to the main source screen or previous screen.

iDataLink Operation

When the unit is connected to the car's iDataLink module, you can transfer and receive data between the car and the unit to check the car's status, or to make various operations from the unit.

- An iDataLink module (sold separately) is required.
- Available functions differ depending on your vehicle. For details, refer to your vehicle's instruction manual.

About Audio Interrupt

Audio Interrupt is the function that outputs sound from the unit when Voice Information (audio reading from the phone book, etc.)* from the vehicle occurs.

- The Audio Interrupt function of the vehicle differs depending on the type and grade of the vehicle.
- * For your safety, when interrupted with Voice Information, you cannot operate the buttons on the front panel or the touch buttons on the display, except for some operations.
 - The operating restrictions may differ depending on which mode the unit is in during Voice Information.
 - You can use the [+] / [-] (UP/DOWN) button to control the volume of Voice Information.

Access to iDataLink Mode

You can check the car's status, set the air conditioning, etc.

1 Touch the (HOME) button to select Vehicle info mode.

- The iDataLink mode screen selected in "Setting the Default Vehicle Screen" (page 19) is displayed.

2 Touch the desired tag on the top of the screen.

Select item:

Climate / Gauges / Park Sensor / Vehicle Info. / Car Setting

- The displayed tag options differ depending on the type of vehicle.

3 Adjust or confirm the item/information accordingly.

- Operable functions and displays may differ depending on the vehicle.

iDataLink Function Screen example

■ Climate screen example

You can control the temperature inside the vehicle, etc.



■ Gauges screen example

You can check the vehicle's speed, the engine's rotation speed, etc.



■ Parking sensor screen example

You can check the distance from the front and rear of the vehicle to an obstacle.

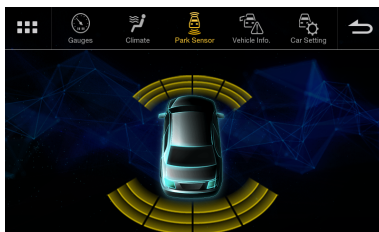

- If the car sensor detects an obstacle, the screen automatically changes to the Parking sensor screen. For details, see "About Parking Sensor screen" (page 56).

■ Vehicle Information screen example

You can check for open doors, check the tire pressure, the battery life, etc. for the vehicle.



■ Car Setting screen example (Generic List screen)

The Generic List/PopUp Window/Current source control screen is displayed.

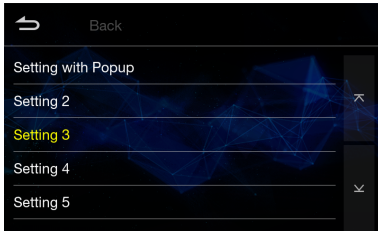

About Parking Sensor screen

The Parking sensor screen turns on when the front or rear sensor on your vehicle detects an obstacle within a certain distance.

Parking Sensor Full screen example

When the front or rear sensor detects an obstacle within a certain distance, the Parking Sensor screen is displayed, and the indicator (① - ⑧) that corresponds with that area lights up.

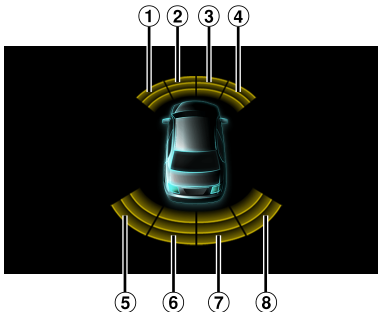

Indicator colors when an obstacle is detected.

- Red: close distance
- Orange: medium distance
- Yellow: long distance

- Depending on the speed of the vehicle, when moving faster than a certain speed, the Parking Sensor screen may not be displayed.
- Vehicles that do not have the obstacle detection sensor cannot use this function.

Parking Sensor Camera interlock screen example (Rear camera)

You can check for obstacles through an interlocked camera image by connecting a Rear Camera or Front Camera.



- Touch the Camera image area to switch to the Camera full screen.
(While displaying the Camera full screen, touch the Camera screen, then touch [↔] to return to the Parking Sensor Camera interlock screen.)
- Touch the car icon to switch to the Parking sensor full screen.
(Touch [↔] on the Parking Sensor full screen to return to the Parking Sensor Camera interlock display.)
- To use this function, set the Camera Select setting of the Rear Camera and Front Camera, to "Rear" or "Front". For details, see "Camera Input Setting" (page 21 or page 23).

Factory Media Operation

You can operate the Factory Audio (USB/iPod/Bluetooth Audio) from this unit.

Touch the [HOME] button to select Factory Media mode.

The display shows the Factory Media mode screen.

- For the basic operations on Factory Media mode, refer to "USB Audio" (page 35), "iPod mode on iPhone (Optional)" (page 39) and "Bluetooth Audio" (page 49).

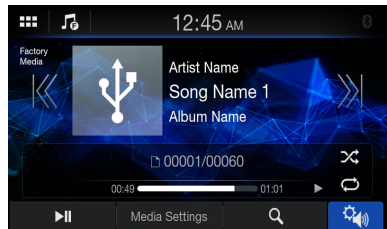

Swipe to the right or left to change to the Function mode.

- Available functions differ depending on your vehicle.

Factory SiriusXM Operation

You can operate the Factory SiriusXM from this unit.

Touch the  (HOME) button to select Factory SiriusXM mode.

The display shows the Factory SiriusXM mode screen.

- For the basic operations on Factory SiriusXM mode, refer to “SiriusXM Satellite Radio Operation (Optional)” (page 41).

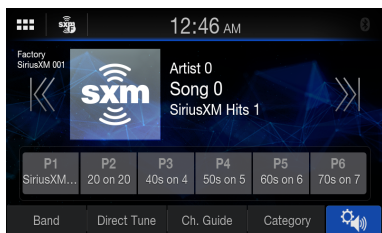

Swipe to the right or left to change to the Function mode.

- Available functions differ depending on your vehicle.

Information

Product Software Update

This product use software that can be updated through a USB flash drive. Download the software from the Alpine website and update the product using the USB flash drive.

Updating this product

Check the Alpine website for details on updating.
<http://www.alpine-usa.com>

Important information on the software

About the software license of the product

The software installed in the product contains open-source software.

For details, refer to the “Open source licenses” screen on this unit. See “Displaying Warranty/Copyright Information” (page 18).

About the Supported Formats

About MP3/WMA/AAC/FLAC/WAV

CAUTION

Except for private use, duplicating audio data (including MP3/WMA/AAC/FLAC/WAV data) or distributing, transferring, or copying it, whether for free or for a fee, without permission of the copyright holder is strictly prohibited by the Copyright Act and by international treaty.

What is MP3?

MP3, whose official name is “MPEG Audio Layer 3,” is a compression standard prescribed by the ISO, the International Standardization Organization and MPEG which is a joint activity institution of the IEC.

MP3 files contain compressed audio data. MP3 encoding is capable of compressing audio data at extremely high ratios, reducing the size of music files to as much as one-tenth their original size. This is achieved while still maintaining near CD quality. The MP3 format realizes such high compression ratios by eliminating the sounds that are either inaudible to the human ear or masked by other sounds.

What is WMA?

WMA, or “Windows Media™ Audio,” is compressed audio data.

WMA is similar to MP3 audio data.

What is AAC?

AAC is the abbreviation for “Advanced Audio Coding,” and is a basic format of audio compression used by MPEG2 or MPEG4.

What is FLAC?

FLAC (Free Lossless Audio Codec) is an audio file codec for lossless compression, developed and offered as open source software.

Codecs with lossy compression forms, such as MP3 and AAC, reduce part of the data to improve compression efficiency.

However, FLAC can reconstruct compressed data to be an identical copy of the original data by performing lossless compression. The compression ratio of FLAC is about 50%.

Method for creating MP3/WMA/AAC/FLAC/WAV (USB Flash drive) files

Audio data is compressed using software with MP3/WMA/AAC/FLAC/WAV (USB Flash drive) codecs. For details on creating MP3/WMA/AAC/FLAC/WAV (USB Flash drive) files, refer to the user's manual for that software.

MP3/WMA/AAC/FLAC/WAV (USB Flash drive) files that are playable on this device have the file extensions.

MP3: "mp3"

WMA: "wma"

AAC: "m4a"

FLAC: "flac"/"fla"

WAV: "wav"

WMA is not supported for the following files, Windows Media Audio Professional, Windows Media Audio 10 std or Windows Media Audio 10 Pro Lossless.

There are many different versions of the AAC format. Confirm that the software being used conforms to the acceptable formats listed above. It's possible that the format may be unplayable even though the extension is valid.

Playback of AAC files encoded by iTunes is supported.

Supported playback sampling rates and bit rates

MP3 (USB Flash drive)

Sampling rates: 8 kHz, 11.025 kHz, 12 kHz,
16 kHz, 22.05 kHz, 24 kHz,
32 kHz, 44.1 kHz, 48 kHz

Bit rates: 8 - 320 kbps

WMA (USB Flash drive)

Sampling rates: 8 - 48 kHz

Bit rates: 8 - 384 kbps

AAC (USB Flash drive)

Sampling rates: 8 - 48 kHz

Bit rates: 8 - 384 kbps

FLAC (USB Flash drive)

Sampling rates: 8 - 48 kHz

Bit rates: 8 - 384 kbps

WAV (USB Flash drive)

Sampling rates: 8 - 48 kHz

Bit rates: 64 - 1,536 kbps

This device may not play back correctly depending on sampling rates.

ID3 tags/WMA tags

This device supports ID3 tag v1.0, v1.1, v2.2, v2.3, v2.4, and WMA tag Ver.1.x. If tag data is in an MP3/WMA/AAC file, this device can display the title (track title), artist name, and album name ID3 tag/WMA tag data.

For non-supported characters, "?" is displayed.

The number of characters may be limited, or not correctly displayed, depending on the tag information.

Playing back MP3/WMA/AAC/FLAC/WAV

MP3/WMA/AAC files are prepared, then written to a USB flash drive.

- Maximum numbers of playable files/folders
USB Flash drive: 10,000 files/folders (including Root Folder)
- Largest playable file size: 512 MB

Playback may not be performed if a USB flash drive exceeds the limitations described above.

If a file/folder name is long, the maximum possible number of files may decrease.

- Both Audio and Video files are counted if their formats are playable on this unit.

Media supported

The media that this device can play back a USB flash drive.

Corresponding File Systems

This device supports FAT 16/32.

The maximum nested folder depth is 8 (including the root directory). File names are limited to 256 characters (including the extension).

Valid characters for folder/file names are letters A-Z (all caps), numbers 0-9, and '_' (underscore).

Order of files

Files are played back in the order that the writing software writes them to the USB flash drive. Therefore, the playback order may not be what's expected. Verify the writing order in the software's documentation. The playback order of the folders and files is as follows. (The following numbers may differ from actually displayed numbers.)

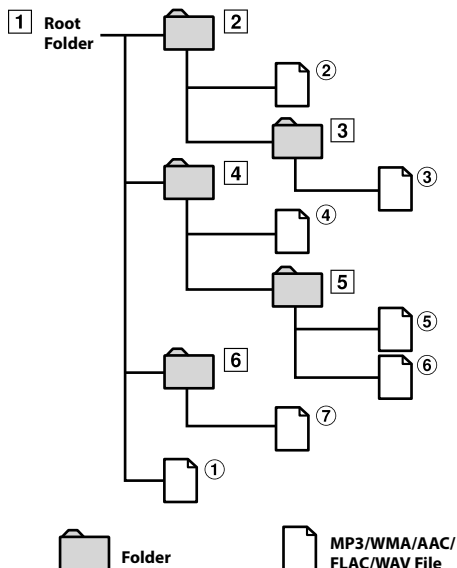

Terminology

Bit rate

This is the “sound” compression rate specified for encoding. The higher the bit rate, the higher the sound quality, but also the larger the files.

Sampling rate

This value shows how many times per second the data is sampled (recorded). For example, music CDs use a sampling rate of 44.1 kHz, so the sound is sampled (recorded) 44,100 times per second. The higher the sampling rate, the higher the sound quality, but also the larger the volume of data.

Encoding

Converting music CDs, WAVE (AIFF) files, and other sound files into the specified audio compression format.

Tag

Song information such as track titles, artist names, album names, etc., written into MP3/WMA/AAC/FLAC/WAV (USB flash drive) files.

Root folder

The root folder (or root directory) is found at the top of the file system. The root folder contains all folders and files. It is created automatically for all USB flash drive.

In Case of Difficulty

If you encounter a problem, please turn the power off, then on again. If the unit is still not functioning normally, please review the items in the following checklist. This guide will help you isolate the problem if the unit is at fault. Otherwise, make sure the rest of your system is properly connected, or then consult your authorized Alpine dealer.

Basic

No function or display.

- Vehicle's ignition is off.
 - If connected according to the instructions, the unit will not operate with the vehicle's ignition off.
- Improper power lead connections.
 - Check power lead connections.
- Blown fuse.
 - Check the fuse on the battery lead of the unit; replace with the proper value if necessary.

No sound or unnatural sound.

- Incorrect setting of volume/balance/fader controls.
 - Readjust the controls.
- Connections are not properly or securely made.
 - Check the connections and firmly connect.

Screen not displayed.

- Brightness/Contrast control is set at the minimum position.
 - Adjust the Brightness/Contrast control.
- Temperature in the vehicle is too low.
 - Increase the vehicle's interior temperature to operation temperature range.
- Connections to the Auxiliary Device are not securely made.
 - Check the connections and firmly connect.
- The Parking Brake Lead is not connected.
- The Parking Brake is not engaged.
 - Connect the Parking Brake Lead, then engage the Parking Brake.

Movement of displayed picture is abnormal.

- Temperature in the vehicle is too high.
 - Allow the vehicle's interior temperature to cool.

Radio

Unable to receive stations.

- No antenna, or open connection in the antenna cable.
 - Make sure the antenna is properly connected; replace the antenna or cable if necessary.

Unable to tune stations in the seek mode.

- You are in a weak signal area.
 - Make sure the tuner is in DX mode.
- If the area you are in is a primary signal area, the antenna may not be grounded and connected properly.
 - Check your antenna connections; make sure the antenna is properly grounded at its mounting location.
- The antenna may not be the proper length.
 - Make sure the antenna is fully extended; if broken, replace the antenna with a new one.

Broadcast is noisy.

- The antenna is not the proper length.
 - Extend the antenna fully; replace it if it is broken.
- The antenna is poorly grounded.
 - Make sure the antenna is grounded properly at its mounting location.
- The station signal is weak and noisy.
 - If above solution does not work, tune in another station.

USB Audio

Unit does not operate.

- Condensation.
 - Wait a while (about 1 hour) for the condensation to dry.

Picture is unclear or noisy.

- Vehicle's battery power is weak.
 - Check the battery power and wiring.
(The unit may malfunction if the battery power is under 11 volts with a load applied.)

Handsfree Phone

Ringtone is small

- Depending on your phone, the ringtone volume may be small, it is not a failure.

If this Message Appears

Various messages are displayed on the screen during operation. In addition to the messages telling you the current status or providing guidance for the next operation, there are also the following error messages. If one of these error messages is displayed, carefully follow the instructions in the solution column.

System

This operation is prohibited for your safety.

- A setup operation, etc., was carried out while the vehicle was running.
 - Move the vehicle to a safe location, stop, and engage the parking brake, then carry out this operation.

Unsupported USB device connected.

- A USB flash drive with a hub is connected.
 - You cannot play back from a USB flash drive with a hub. USB hub connections are also not supported.
-

Audio/Visual

Unsupported USB device connected.

- An iPhone that is not supported by the unit is connected.
 - Connect an iPhone that is supported by the unit.
 - A USB device that is not supported by the unit is connected.
 - Attempt to connect another USB flash drive.
 - Communication error.
 - Turn the ignition key off, and then set to ON again.
 - Check the display by reconnecting between the iPhone and the unit, using the iPhone cable.
 - Check the display by reconnecting between the USB flash drive and the unit.
 - Caused by the iPod/iPhone Software Version not being compatible with this unit.
 - Update the iPhone Software Version to be compatible with this unit.
 - The iPhone is not verified.
 - Change to another iPhone.
-

No Song

- There are no data in the iPhone.
 - Download data to the iPhone and connect to the unit.
-

No File

- There are no data in the USB flash drive.
 - Download data to the USB flash drive and connect to this unit.
-

File format not supported.

- A copy-protected WMA file has been detected.
 - You can only play back non-copy-protected files.
 - A sampling rate/bit rate not supported by the unit is used.
 - Use a sampling rate/bit rate supported by the unit.
-

Bluetooth

No Bluetooth

- The Bluetooth audio device was not connected correctly.
 - Check the settings for the unit and the Bluetooth audio device and reconnect.
-

SiriusXM

Check Tuner

- The SiriusXM Tuner is disconnected or the unit is having trouble communicating with the Tuner.
 - Connect the Tuner or check the Tuner connection to the back of the unit.
-

Check Antenna

- The SiriusXM Satellite Radio antenna or cable is either damaged or not connected correctly to the SiriusXM Tuner.
 - Check that the SiriusXM antenna cable is connected to the SiriusXM Tuner and check that the antenna cable is not kinked or otherwise damaged. Replace the antenna if necessary.
 - SiriusXM products are available at your local car audio retailer or online at www.shop.siriusxm.com.
-

No Signal

- The SiriusXM satellite signal is too weak at the current location.
 - Move the vehicle to a location with a clear view of the southern sky.
 - Make sure the Satellite Radio antenna is properly mounted and not obstructed by metal objects.
-

Channel Not Subscribed

Call SiriusXM to Subscribe

- The active channel has become unsubscribed or the requested channel is not available in your subscription package.
 - In the U.S.A., visit www.siriusxm.com or call 1-866-635-2349 if you have questions about your subscription package or would like to subscribe to this channel. In Canada, visit www.siriusxm.ca or call 1-877-438-9677.
 - The unit will revert to the previously selected channel or to channel 1 automatically.
-

Channel <xxx> Not Available

- The active channel is no longer in the SiriusXM channel lineup or the user has entered an invalid channel number.
 - Visit www.siriusxm.com for information on the current channel lineup.
 - The unit will revert to the previous channel or to channel 1 automatically.
-

Subscription Updated

Press Any Key to Continue

- Your subscription has been updated.
 - Touch [OK] to clear this message.
-

Channel <xxx> Locked

- A locked channel is selected.
 - Input the passcode on the number keypad screen, see “Parental Lock Function” (page 43). If wrong passcode is entered, “Incorrect Pass Code entered” will be displayed and the unit will revert to the previous channel.
-

Specifications

MONITOR SECTION

Screen Size	6.95"
LCD Type	Transparent type TN LCD
Operation System	TFT active matrix
Number of Picture Elements	1,152,000 pcs. (800 × 480 × 3 (RGB))
Effective Number of Picture Elements	99% or more
Illumination System	LED

FM TUNER SECTION

Tuning Range	87.7 – 107.9 MHz
Mono Usable Sensitivity	9.3 dBf (0.8 μV/75 ohms)
50 dB Quieting Sensitivity	13.5 dBf (1.3 μV/75 ohms)
Alternate Channel Selectivity	80 dB
Signal-to-Noise Ratio	65 dB
Stereo Separation	35 dB
Capture Ratio	2.0 dB

AM TUNER SECTION

Tuning Range	530 – 1,710 kHz
Usable Sensitivity	25.1 μV/28 dBf

HD RADIO SECTION

HD Sensitivity	FM: 83 dBm AM: 90 dBm
Distortion	0.3 %
Separation	65 dB

HD RADIO SECTION

HD Sensitivity	FM: 83 dBm AM: 90 dBm
Distortion	0.3 %
Separation	65 dB

USB SECTION

USB requirements	USB 2.0
Max. Power Consumption	1,500 mA (CDP Support)
USB Class	USB (Play From Device)/ USB (Mass Storage Class)
File System	FAT16/32
Number of Channels	2-Channels (Stereo)
Frequency Response*1	5 – 20,000 Hz (±1 dB)
Total Harmonic Distortion	0.008% (at 1 kHz)
Dynamic Range	95 dB (at 1 kHz)
Signal-to-Noise Ratio	100 dB
Channel Separation	85 dB (at 1 kHz)

*1 Frequency response may differ depending on the encoder software/bit rate.

HDMI SECTION

Input Format	720p/480p/VGA
--------------	---------------

Bluetooth SECTION

Bluetooth Specification	Bluetooth V4.1
Output Power	+4 dBm Ave. (Power class 2)
Profile	HFP (Hands-Free Profile) PBAP (Phone Book Access Profile) A2DP (Advanced Audio Distribution Profile) AVRCP (Audio/Video Remote Control Profile)

GENERAL

Power Requirement	14.4 V DC (11–16 V allowable)
Operating temperature	-4°F to +140°F (-20°C to + 60°C)
Power Output	16 W RMS × 4*2

*2 Primary amplifier ratings per CEA-2006 Standard

- Power output: measured at 4 Ohms and ≤ 1% THD+N
- S/N: 70 dBA (reference: 1 W into 4 Ohms)

Weight	1.0 kg (2 lbs. 3.3 oz)
--------	------------------------

Audio output level	Preout (Front, Rear): 4V/10k ohms (max.)
	Preout (Subwoofer): 4V/10k ohms (max.)

CHASSIS SIZE

Width	178 mm (7")
Height	100 mm (4")
Depth	60 mm (2-6/16")

- *Due to continuous product improvement, specifications and design are subject to change without notice.*
- *The LCD panel is manufactured using an extremely high precision manufacturing technology. Its effective pixel ratio is over 99.99%. This means that there is a possibility that 0.01% of the pixels could be either always ON or OFF.*

Installation and Connections

Before installing or connecting the unit, please read the following and pages 6 to 8 of this manual thoroughly for proper use.

WARNING

KEEP SMALL OBJECTS SUCH AS SCREWS OUT OF THE REACH OF CHILDREN.

Swallowing them may result in serious injury. If swallowed, consult a physician immediately.

MAKE THE CORRECT CONNECTIONS.

Failure to make the proper connections may result in fire or product damage.

USE ONLY IN CARS WITH A 12 VOLT NEGATIVE GROUND.

(Check with your dealer if you are not sure.) Failure to do so may result in fire, etc.

BEFORE WIRING, DISCONNECT THE CABLE FROM THE NEGATIVE BATTERY TERMINAL.

Failure to do so may result in electric shock or injury due to electrical shorts.

DO NOT ALLOW CABLES TO BECOME ENTANGLED IN SURROUNDING OBJECTS.

Arrange wiring and cables in compliance with the manual to prevent obstructions when driving. Cables or wiring that obstruct or hang up on places such as the steering wheel, gear lever, brake pedals, etc. can be extremely hazardous.

DO NOT SPLICE INTO ELECTRICAL CABLES.

Never cut away cable insulation to supply power to other equipment. Doing so will exceed the current carrying capacity of the wire and result in fire or electric shock.

DO NOT DAMAGE PIPE OR WIRING WHEN DRILLING HOLES.

When drilling holes in the chassis for installation, take precautions so as not to contact, damage or obstruct pipes, fuel lines, tanks or electrical wiring. Failure to take such precautions may result in fire.

DO NOT USE BOLTS OR NUTS IN THE BRAKE OR STEERING SYSTEMS TO MAKE GROUND CONNECTIONS.

Bolts or nuts used for the brake or steering systems (or any other safety-related system), or tanks should NEVER be used for installations or ground connections. Using such parts could disable control of the vehicle and cause fire etc.

DO NOT INSTALL IN LOCATIONS WHICH MIGHT HINDER VEHICLE OPERATION, SUCH AS THE STEERING WHEEL OR GEARSHIFT.

Doing so may obstruct forward vision or hamper movement etc. and results in serious accident.

CAUTION

HAVE THE WIRING AND INSTALLATION DONE BY EXPERTS.

The wiring and installation of this unit requires special technical skill and experience. To ensure safety, always contact the dealer where you purchased this product to have the work done.

USE SPECIFIED ACCESSORY PARTS AND INSTALL THEM SECURELY.

Be sure to use only the specified accessory parts. Use of other than designated parts may damage this unit internally or may not securely install the unit in place. This may cause parts to become loose resulting in hazards or product failure.

ARRANGE THE WIRING SO IT IS NOT CRIMPED OR PINCHED BY A SHARP METAL EDGE.

Route the cables and wiring away from moving parts (like the seat rails) or sharp or pointed edges. This will prevent crimping and damage to the wiring. If wiring passes through a hole in metal, use a rubber grommet to prevent the wire's insulation from being cut by the metal edge of the hole.

DO NOT INSTALL IN LOCATIONS WITH HIGH MOISTURE OR DUST.

Avoid installing the unit in locations with high incidence of moisture or dust. Moisture or dust that penetrates into this unit may result in product failure.

Precautions

- Be sure to disconnect the cable from the (-) battery post before installing your unit. This will reduce any chance of damage to the unit in case of a short-circuit.
- Be sure to connect the color coded leads according to the diagram. Incorrect connections may cause the unit to malfunction or damage to the vehicle's electrical system.
- When making connections to the vehicle's electrical system, be aware of the factory installed components (e.g. on-board computer). Do not tap into these leads to provide power for this unit. When connecting the unit to the fuse box, make sure the fuse for the intended circuit of the unit has the appropriate amperage. When in doubt, consult your Alpine dealer.
- The unit uses female RCA-type jacks for connection to other units (e.g. amplifier) having RCA connectors. You may need an adaptor to connect other units. If so, please contact your authorized Alpine dealer for assistance.
- Be sure to connect the speaker (-) leads to the speaker (-) terminal. Never connect left and right channel speaker cables to each other or to the vehicle body.

Accessory List

Main unit	1
Quick Reference Guide.....	1 set
<Cables>	
Power cable.....	1
USB extension cable.....	1
PRE OUT cable	1
Microphone.....	1
CAN Interface Connector	1
<Main unit mounting parts>	
Screw (M5×8).....	4

Installation

Caution

- Do not block the unit's fan, thus preventing air circulation. If blocked, heat will accumulate inside the unit and may cause a fire.

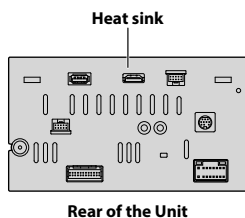

Caution concerning the installation location

Angle of installation

Install at an angle between horizontal and 30°. Note that installing at an angle outside of this range will result in a loss of performance and possibly damage.

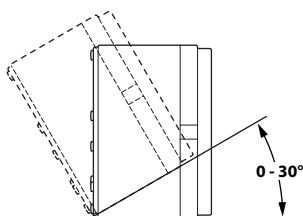

Mounting the Microphone

For safe use, make sure of the following:

- Location is stable and firm.
- Does not interfere with safety equipment.
- Driver's view and operations are not obstructed.
- Microphone is located where the driver's voice can be easily picked up (for example, on the sun visor).

When you speak into the microphone, you should not have to change your driving posture. This may cause a distraction, taking your attention away from safely driving your vehicle. Carefully consider direction and distance while mounting the microphone. Confirm that the driver's voice can be easily picked up at the selected location.

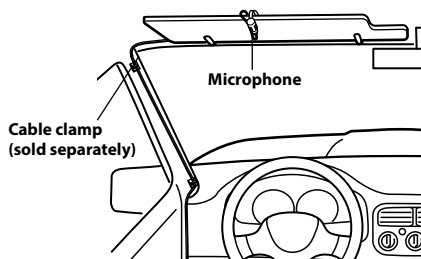

Installation example using the Original Mounting Bracket

- Mount the original mounting bracket to the unit using the supplied screws.

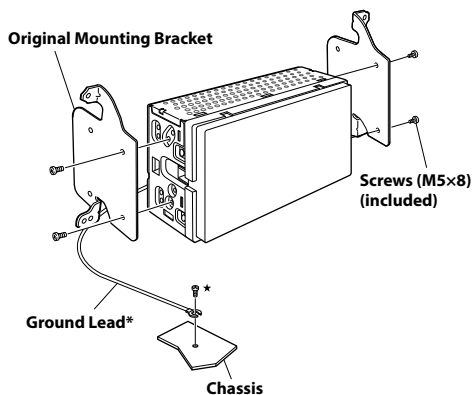

- Connect all other leads of the unit according to details described in the "Connections" (page 65).

- Mount the unit in a car.

* To securely connect the ground lead, use an already installed screw on a metal part of the vehicle (marked (★)) or a clean, bare metal spot on the vehicle's chassis.

- Fix the cables carefully. Do not damage them by mounting them into movable parts, such as the seat rail, or by locating them against sharp or pointed edges.

- Reattach the removed vehicle parts (panels, etc.) or other aftermarket dash kit back onto the vehicle.

Connections

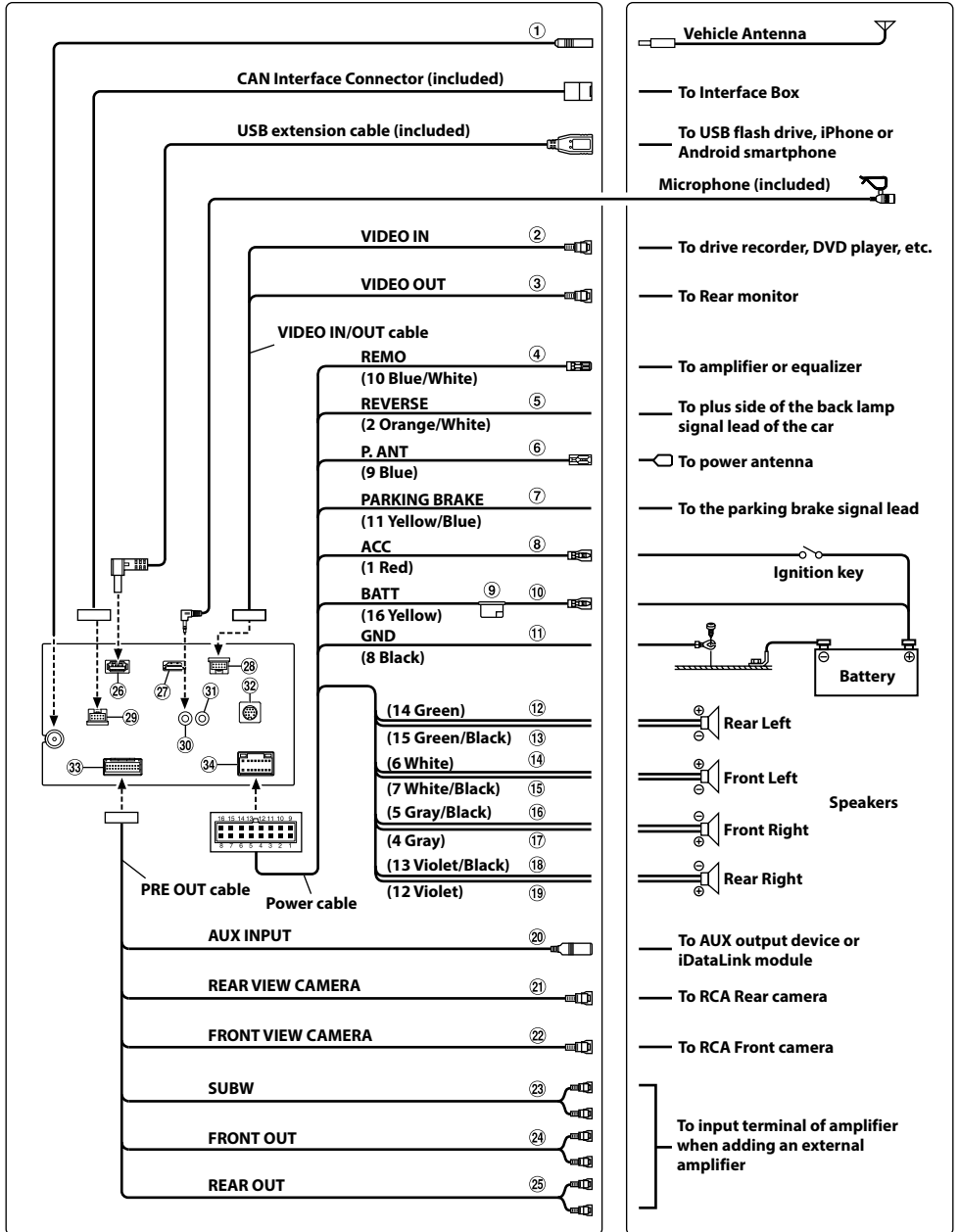

- ① Radio Antenna Receptacle
- ② Video Input Lead
- ③ Video Output Lead
- ④ Remote Turn-On Lead (Blue/White)
Connect this lead to the remote turn-on lead of your amplifier or signal processor.
- ⑤ Reverse Lead (Orange/White)
- ⑥ Power Antenna Lead (Blue)
Connect this lead to the +B terminal of your power antenna, if applicable.
* This lead should be used only for controlling the vehicle's power antenna. Do not use this lead to turn on an amplifier or a signal processor, etc.
- ⑦ Parking Brake Lead (Yellow/Blue)
Connect this lead to the power supply side of parking brake switch to transmit the parking brake status signals to the unit.
- ⑧ Switched Power Lead (Ignition) (Red)
Connect this lead to an open terminal on the vehicle's fuse box or another unused power source that provides (+) 12V only when the ignition is turned on or in the accessory position.
- ⑨ Fuse Holder (15A)
- ⑩ Battery Lead (Yellow)
Connect this lead to the positive (+) post of the vehicle's battery.
- ⑪ Ground Lead (Black)
Connect this lead to a good chassis ground on the vehicle.
Make sure the connection is made to bare metal and is securely fastened using the sheet metal screw provided.
- ⑫ Left Rear (+) Speaker Output Lead (Green)
- ⑬ Left Rear (-) Speaker Output Lead (Green/Black)
- ⑭ Left Front (+) Speaker Output Lead (White)
- ⑮ Left Front (-) Speaker Output Lead (White/Black)
- ⑯ Right Front (-) Speaker Output Lead (Gray/Black)
- ⑰ Right Front (+) Speaker Output Lead (Gray)
- ⑱ Right Rear (-) Speaker Output Lead (Violet/Black)
- ⑲ Right Rear (+) Speaker Output Lead (Violet)

- ⑳ AUX Input Connector
Input lead for AUX video/audio signal or iDataLink audio signal.
 - A separately sold AV/RCA interface cable (4-pole mini AV plug to 3-RCA) is required. For details on using an AV/RCA interface cable (4-pole mini AV plug to 3-RCA), see "Usable AV/RCA Interface Cable (4-pole mini AV plug to 3-RCA)" (page 67).
- ㉑ REAR CAMERA Input RCA Connector
Use when connecting a rear camera with RCA Output Connector.
- ㉒ FRONT CAMER Input RCA Connector
Use when connecting a front camera with RCA Output Connector.
- ㉓ Subwoofer RCA Connectors
- ㉔ Front Output RCA Connectors
Can be used as Front Output RCA Connectors. RED is right and WHITE is left.
- ㉕ Rear Output RCA Connectors
Can be used as Rear Output RCA Connectors. RED is right and WHITE is left.
- ㉖ USB Connector
To USB flash drive, iPhone or Android smartphone.
- ㉗ HDMI Input Connector
 - To connect to the HDMI Input Connector, use an optional HDMI cable with an L-Type (270 degree) connector.
 - Please take note of the size of the HDMI cable's L-Type connector. An HDMI cable with a connector exceeding this size will not be able to connect, as it will interfere with the peripheral cables, stacking amplifiers, etc.

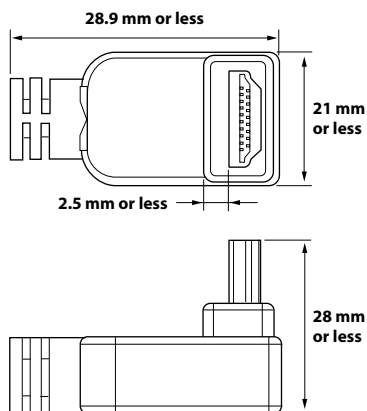

- ㉘ VIDEO Input/Output Connector
- ㉙ MAESTRO Connector
To Interface Box.

- ③⑩ MIC Input Connector
To microphone (included)
- ③⑪ Steering Remote Control Interface Connector
To steering remote control interface.
For details about connections, consult your nearest Alpine dealer.
- ③⑫ SiriusXM Tuner Input Connector
To SiriusXM Tuner (sold separately).
 - For more information on how to install the SiriusXM Connect Vehicle tuner, consult the installation guide included with the tuner.
- ③⑬ AUX/PRE OUT/CAMERA Connector
- ③⑭ Power Supply Connector

Usable AV/RCA Interface Cable (4-pole mini AV plug to 3-RCA)

Wiring convention of this system is as follows;

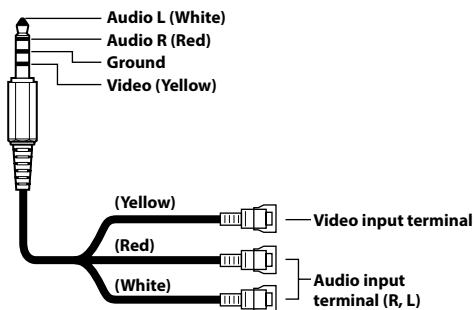

- Configuration commercially available 4-pole mini AV plugs is not standardized.

If an ACC power supply is not available

Connection Diagram of SPST Switch (sold separately)

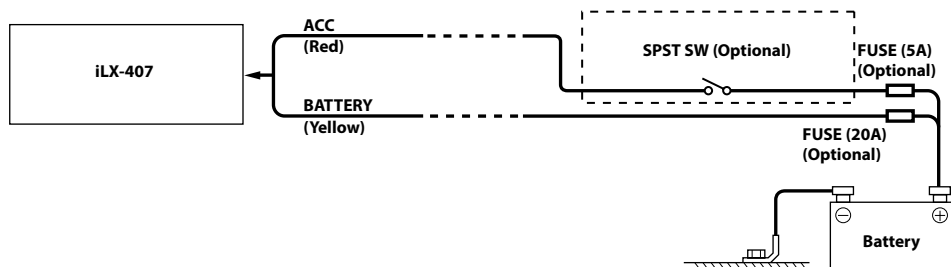

- If your vehicle has no ACC power supply, add an SPST (single-pole, single-throw) switch (sold separately) and fuse (sold separately).
- The diagram and the fuse amperage shown above are in the case when the unit is used individually.
- If the switched power (ignition) lead of the unit is connected directly to the positive (+) post of the vehicle's battery, the unit draws some current (several hundred milliamperes) even when its switch is placed in the OFF position, and the battery may be discharged.

IMPORTANT

Please record the serial number of your unit in the space provided below and keep it as a permanent record. The serial number plate is located on the bottom of the unit.

SERIAL NUMBER: _____
INSTALLATION DATE: _____
INSTALLATION TECHNICIAN: _____
PLACE OF PURCHASE: _____

To prevent external noise from entering the audio system.

- Locate the unit and route the leads at least 10 cm away from the car harness.
- Keep the battery power leads as far away from other leads as possible.
- Connect the ground lead securely to a bare metal spot (remove any paint, dirt or grease if necessary) of the car chassis.
- If you add an optional noise suppressor, connect it as far away from the unit as possible. Your Alpine dealer carries various noise suppressors, contact them for further information.
- Your Alpine dealer knows best about noise prevention measures so consult your dealer for further information.

System Example

Connection of an iPhone

■ When connecting to an iPhone with a Lightning connector

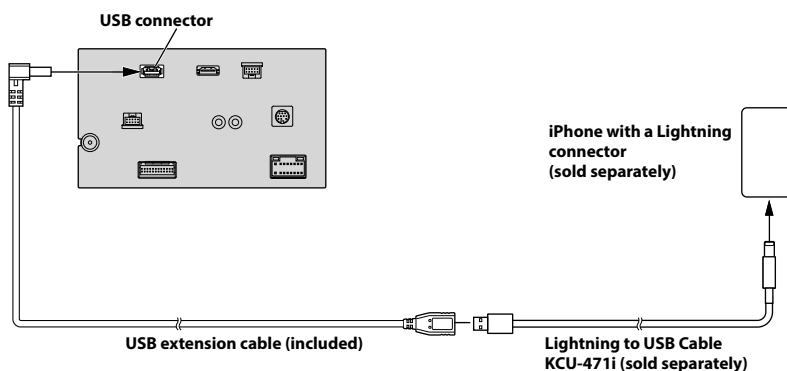

- Do not leave an iPhone in a vehicle for a long time. Heat and humidity may damage the iPhone, and you may not be able to play it again.

Connection of a USB Flash Drive

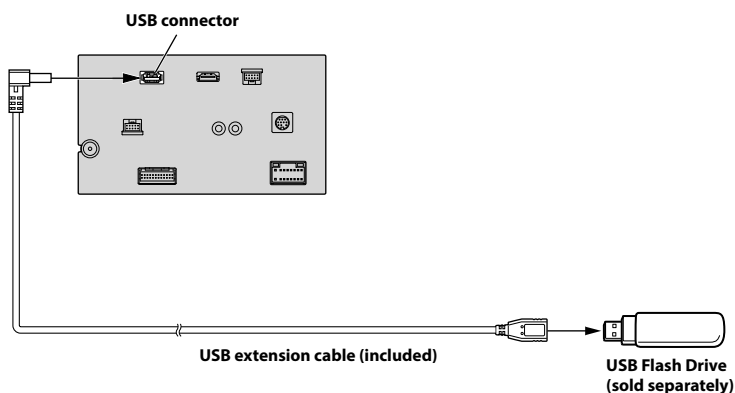

- Do not leave a flash drive in a vehicle for a long time. Heat and humidity may damage the flash drive.

Connection of an HDMI Device (iPhone with a Lightning connector)

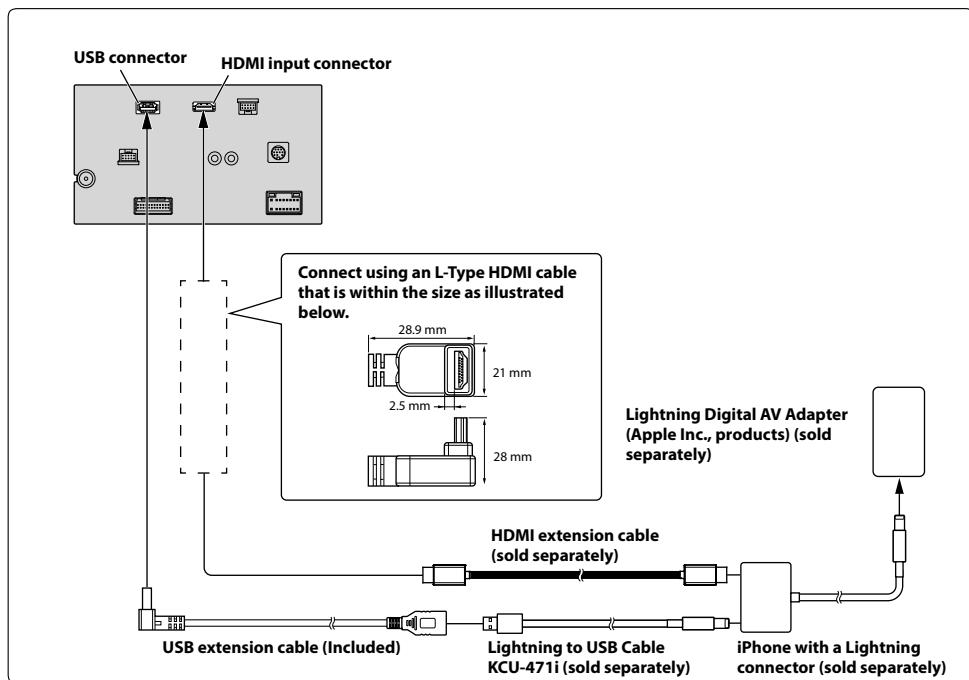

Connection of an HDMI Device (Android device)

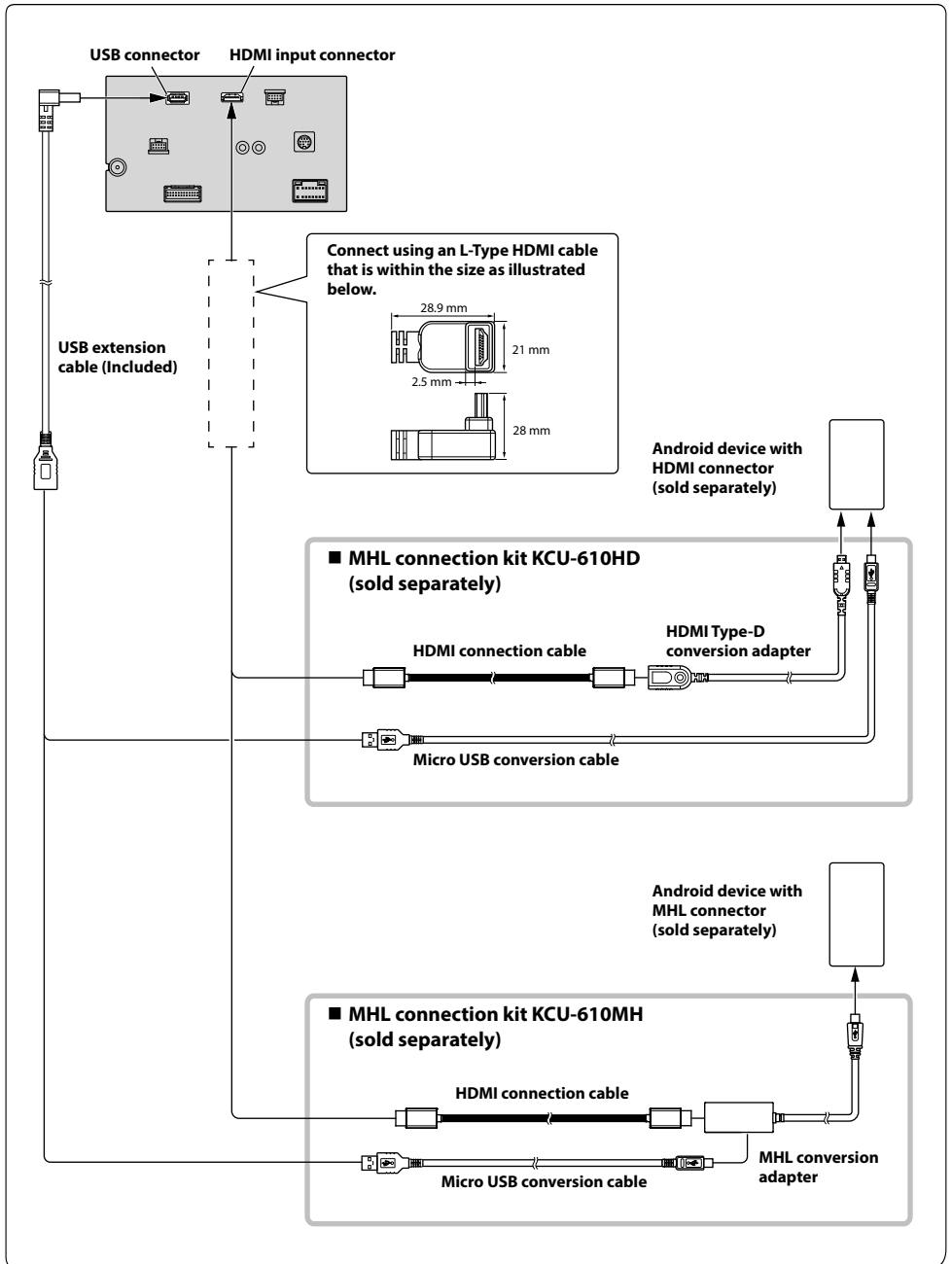

• A connection kit or adapter kit suitable for the type of terminal on the connecting device is required.

Connection of an External Device)

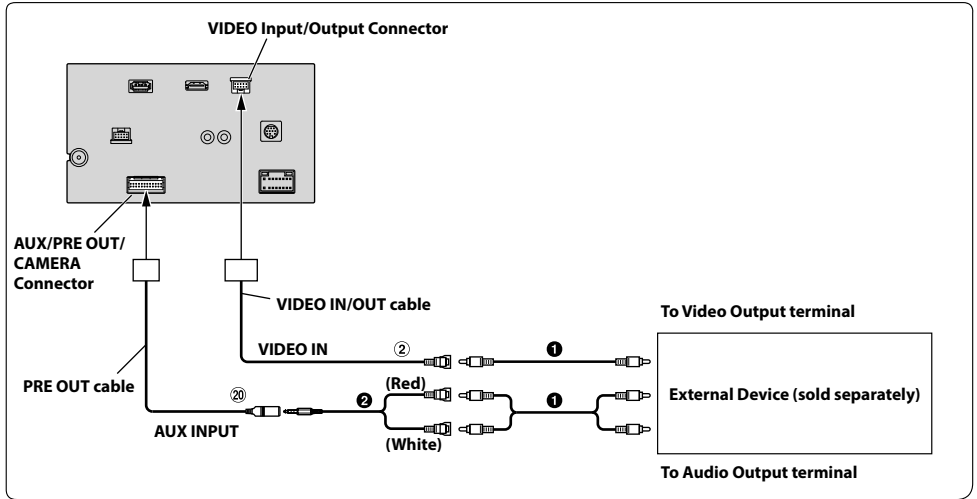

② Video Input Lead

① RCA Extension Cable (sold separately)

⑳ AUX Input Connector

② AV/RCA Interface Cable (4-pole mini AV plug to 3-RCA) (sold separately)

- You can change the name of an external device. For details, refer to “Setting the Auxiliary (AUX) Name” in the OWNER’S MANUAL.
- For details on using an AV/RCA interface cable (4-pole mini AV plug to 3-RCA), see “Usable AV/RCA Interface Cable (4-pole mini AV plug to 3-RCA)” (page 67).

Connection of an External Amplifier

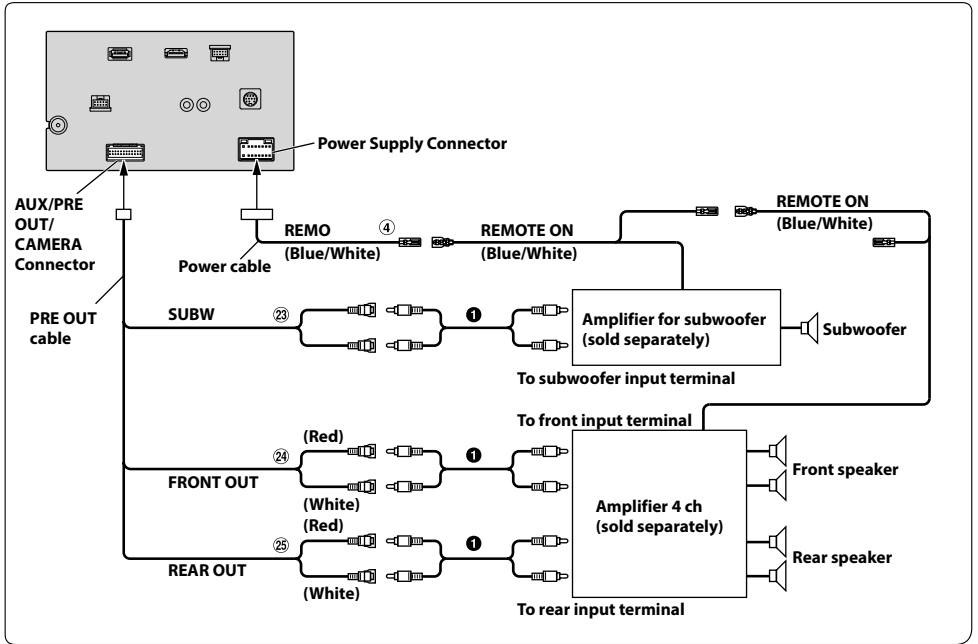

④ Remote Turn-On Lead (Blue/White)

❶ RCA Extension Cable (sold separately)

②③ Subwoofer RCA Connectors

②④ Front Output RCA Connectors

②⑤ Rear Output RCA Connectors

Connection of a Camera

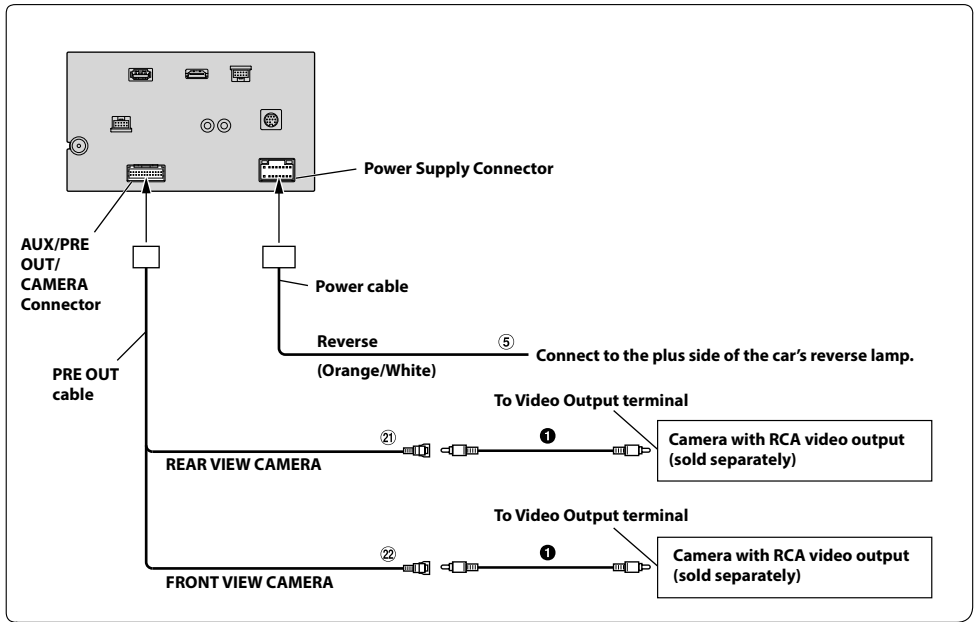

⑤ Reverse Lead (Orange/White)

① RCA Extension Cable (sold separately)

②① REAR CAMERA Input RCA Connector

②② FRONT CAMERA Input RCA Connector



LIMITED WARRANTY

ALPINE ELECTRONICS OF AMERICA, INC. ("Alpine"), is dedicated to quality craftsmanship and is pleased to offer this Warranty. We suggest that you read it thoroughly. Should you have any questions, please contact your Dealer or contact Alpine at one of the telephone numbers listed below.

● PRODUCTS COVERED:

This Warranty covers Car Audio Products and Related Accessories ("the product"). Products purchased in the Canada are covered only in the Canada. Products purchased in the U.S.A. are covered only in the U.S.A.

● LENGTH OF WARRANTY:

This Warranty is in effect for one year from the date of the first consumer purchase.

● WHO IS COVERED:

This Warranty only covers the original purchaser of the product, who must reside in the United States, Puerto Rico or Canada.

● WHAT IS COVERED:

This Warranty covers defects in materials or workmanship (parts and labor) in the product.

● WHAT IS NOT COVERED:

This Warranty does not cover the following:

- ① Damage occurring during shipment of the product to Alpine for repair (claims must be presented to the carrier).
- ② Damage caused by accident or abuse, including burned voice coils caused by over-driving the speaker (amplifier level is turned up and driven into distortion or clipping). Speaker mechanical failure (e.g. punctures, tears or rips). Cracked or damaged LCD panels. Dropped or damaged hard drives.
- ③ Damage caused by negligence, misuse, improper operation or failure to follow instructions contained in the Owner's manual.
- ④ Damage caused by act of God, including without limitation, earthquake, fire, flood, storms or other acts of nature. Any cost or expense related to the removal or reinstallation of the product.
- ⑤ Service performed by an unauthorized person, company or association.
- ⑥ Any product which has the serial number defaced, altered or removed.
- ⑦ Any product which has been adjusted, altered or modified without Alpine's consent.
- ⑧ Any product not distributed by Alpine within the United States, Puerto Rico or Canada.
- ⑨ Any product not purchased from an Authorized Alpine Dealer.

● HOW TO OBTAIN WARRANTY SERVICE:

- ① You are responsible for delivery of the product to an Authorized Alpine Service Center or Alpine for repair and for payment of any initial shipping charges. Alpine will, at its option, repair or replace the product with a new or reconditioned product without charge. If the repairs are covered by the warranty, and if the product was shipped to an Authorized Alpine Service Center or Alpine, Alpine will pay the return shipping charges.

- ② You should provide a detailed description of the problem(s) for which service is required.
- ③ You must supply proof of your purchase of the product.
- ④ You must package the product securely to avoid damage during shipment. To prevent lost packages it is recommended to use a carrier that provides a tracking service.

● HOW WE LIMIT IMPLIED WARRANTIES:

ANY IMPLIED WARRANTIES INCLUDING FITNESS FOR USE AND MERCHANTABILITY ARE LIMITED IN DURATION TO THE PERIOD OF THE EXPRESS WARRANTY SET FORTH ABOVE AND NO PERSON IS AUTHORIZED TO ASSUME FOR ALPINE ANY OTHER LIABILITY IN CONNECTION WITH THE SALE OF THE PRODUCT.

● HOW WE EXCLUDE CERTAIN DAMAGES:

ALPINE EXPRESSLY DISCLAIMS LIABILITY FOR INCIDENTAL AND CONSEQUENTIAL DAMAGES CAUSED BY THE PRODUCT. THE TERM "INCIDENTAL DAMAGES" REFERS TO EXPENSES OF TRANSPORTING THE PRODUCT TO THE ALPINE SERVICE CENTER, LOSS OF THE ORIGINAL PURCHASER'S TIME, LOSS OF THE USE OF THE PRODUCT, BUS FARES, CAR RENTALS OR OTHERS COSTS RELATING TO THE CARE AND CUSTODY OF THE PRODUCT. THE TERM "CONSEQUENTIAL DAMAGES" REFERS TO THE COST OF REPAIRING OR REPLACING OTHER PROPERTY WHICH IS DAMAGED WHEN THIS PRODUCT DOES NOT WORK PROPERLY. THE REMEDIES PROVIDED UNDER THIS WARRANTY ARE EXCLUSIVE AND IN LIEU OF ALL OTHERS.

● HOW STATE/PROVINCIAL LAW RELATES TO THE WARRANTY:

This Warranty gives you specific legal rights, and you may also have other rights which vary from state to state and province to province. In addition, some states/provinces do not allow limitations on how long an implied warranty lasts, and some do not allow the exclusion or limitation of incidental or consequential damages. Accordingly, limitations as to these matters contained herein may not apply to you.

● IN CANADA ONLY:

This Warranty is not valid unless your Alpine car audio product has been installed in your vehicle by an Authorized Installation Center, and this warranty stamped upon installation by the installation center.

● HOW TO CONTACT CUSTOMER SERVICE:

Should the product require service, please call the following number for your nearest Authorized Alpine Service Center.

CAR AUDIO	1-800-ALPINE-1 (1-800-257-4631)
NAVIGATION	1-888-NAV-HELP (1-888-628-4357)

Or visit our website at: <http://www.alpine-usa.com>

ALPINE ELECTRONICS OF AMERICA, INC., 1500 Atlantic Blvd, Auburn Hills, Michigan 48326, U.S.A.
Do not send products to this address.

Call the toll free telephone number or visit the website to locate a service center.

About the Rules of Bluetooth Electromagnetic Radiation Regulation

USA/Canada	<p>FCC/IC CAUTION</p> <p>This device complies with Industry Canada's license-exempt RSSs. Operation is subject to the following two conditions:</p> <p>(1) This device may not cause interference; and</p> <p>(2) This device must accept any interference, including interference that may cause undesired operation of the device.</p> <p>Changes or modifications not expressly approved by the party responsible for compliance could void the user's authority to operate the equipment.</p> <p>This equipment complies with FCC/IC radiation exposure limits set forth for an uncontrolled environment and meets the FCC radio frequency (RF) Exposure Guidelines and RSS-102 of the IC radio frequency (RF) Exposure rules. This equipment has very low levels of RF energy that it deemed to comply without maximum permissive exposure evaluation (MPE). But it is desirable that it should be installed and operated keeping the radiator at least 20 cm or more away from person's body.</p>
	<p>Le présent appareil est conforme aux CNR d'Industrie Canada applicables aux appareils radio exempts de licence.</p> <p>L'exploitation est autorisée aux deux conditions suivantes :</p> <p>(1) l'appareil ne doit pas produire de brouillage;</p> <p>(2) l'utilisateur de l'appareil doit accepter tout brouillage radioélectrique subi, même si le brouillage est susceptible d'en compromettre le fonctionnement.</p> <p>Cet équipement est conforme aux limites d'exposition aux rayonnements énoncées pour un environnement non contrôlé et respecte les règles les radioélectriques (RF) de la FCC lignes directrices d'exposition et d'exposition aux fréquences radioélectriques (RF) CNR-102 de l'IC. Cet équipement émet une énergie RF très faible qui est considérée conforme sans évaluation de l'exposition maximale autorisée (MPE). Cependant, il est souhaitable qu'il devrait être installé et utilisé en gardant une distance de 20 cm ou plus entre le radiateur et le corps humain.</p>

Don't forget to take a moment to protect your purchase by registering your product now at the following address: www.alpine-usa.com/registration.

N'oubliez pas de consacrer un moment à la protection de votre achat en enregistrant votre produit dès maintenant à l'adresse suivante : www.alpine-usa.com/registration.

Recuerde que con solo unos pocos pasos podrá proteger su producto, registrándolo a través de la siguiente dirección: www.alpine-usa.com/registration.